

17. Marino, R. On-line stator and rotor resistance estimation for induction motors [Text] / R. Marino, S. Peresada, P. Tomei // IEEE Transactions on Control Systems Technology. – 2000. – Vol. 8, Issue 3. – P. 570–579. doi: 10.1109/87.845888
18. Thomson, W. T. Current signature analysis to detect induction motor faults [Text] / W. T. Thomson, M. Fenger // IEEE Industry Applications Magazine. – 2001. – Vol. 7, Issue 4. – P. 26–34. doi: 10.1109/2943.930988
19. Shavkun, V. M. Methods of monitoring the parameters of traction electric motors in the process of operation of rolling stock of urban electric transport [Text] / V. M. Shavkun, V. M. Bushma // Communal economy of cities. – 2011. – Issue 97. – P. 272–278.
20. Bondarenko, V. H. Teoriya imovirnostei i matematychna statystyka [Text] / V. H. Bondarenko, I. Yu. Kanivska, S. M. Paramonova. – Kharkiv: NTTU «KhPI», 2006. – 125 p.

UDC 621.577; 621.564

DOI: 10.15587/1729-4061.2017.112113

THERMODYNAMIC ANALYSIS OF AIR-COMPRESSION REFRIGERATING MACHINE BASED ON THE EXERGY COST THEORY

Розроблено методикку проведення поглибленого термодинамічного аналізу повітряно-компресійних холодильних машин і теплових насосів на основі теорії ексергетичної вартості. Методика враховує нееквівалентність ексергетичних втрат в різних ланках процесу термотрансформації та їх вплив на споживання ексергії, що підводиться до системи. Сформовано термoeкономічну модель, за допомогою якої досліджено вплив внутрішньої незворотності, що зумовлена процесами в компресорі і детандері, на ексергетичну ефективність повітряно-компресійної холодильної машини (ПХМ). Визначено аномалії і дисфункції в елементах технологічної схеми ПХМ

Ключові слова: термoeкономічна модель, ексергетична вартість, термодинамічний аналіз, повітряно-компресійні холодильні машини, теплонасосні установки

Разработана методика проведения углубленного термодинамического анализа воздушно-компрессионных холодильных машин и тепловых насосов на основе теории эксергетической стоимости. Методика учитывает неэквивалентность эксергетических потерь в различных звеньях процесса термотрансформации и их влияния на потребление подводимой к системе эксергии. Сформирована термoeкономическая модель, с помощью которой исследовано влияние внутренней необратимости, обусловленной процессами в компрессоре и детандере, на эксергетическую эффективность воздушно-компрессионной холодильной машины (ВХМ). Определены аномалии и дисфункции в элементах технологической схемы ВХМ

Ключевые слова: термoeкономическая модель, эксергетическая стоимость, термодинамический анализ, воздушно-компрессионные холодильные машины, теплонасосные установки

D. Kharlampidi
Doctor of Technical Sciences,
Senior Researcher, Leading Researcher*
E-mail: kharlampidi@ipmach.kharkov.ua

V. Tarasova
PhD, Senior Researcher*
E-mail: tarasova@nas.gov.ua

M. Kuznetsov
PhD, Researcher*
E-mail: childeric1975@gmail.com

E. Voytenko
Postgraduate Student*
E-mail: evhenii.voytenko@gmail.com

*Department for modeling and identification of thermal processes
A. N. Podgorny Institute For
Mechanical Engineering Problems
Pozharsky str., 2/10, Ukraine, Kharkiv, 61046

1. Introduction

In recent years, interest in the use of air-compression refrigerating machines (ARM) in air-conditioning systems and air heat-pump installations (AHPI) of heating systems has been reviving worldwide. It is mainly due to prohibitive measures dictated by the need of improving the environmental situation. Imposing restrictions of the Montreal and Kyoto Protocols related to the use of ozone-hazardous freons in refrigeration and heat pump equipment will gradually

result in a reduction of the scope of application of vapor-compression refrigerating machines and heat pumps. Obviously, other thermal transformation technologies that are safer for environment will occupy the vacant niche. A special position is occupied by air-compression refrigerating machines and air heat-pump installations operating according to the Brayton reverse cycle in which air is both a source of low-potential heat and a refrigerant.

Aviation turbo-expanders with exhausted engine life can be used as ARM and AHPI equipment. Use of such “conver-

sion” ARM and AHPI is possible in microclimate systems for underground structures of metro stations [1].

In this connection, the current problem is development of schematic solutions for ARM and AHPI to incorporate them into existing ventilation and heating systems of metro stations. To solve this problem, it is necessary to perform a work package which can be divided into several stages.

Stage 1 involves a search for rational schematic solutions for ARM and AHPI as well as the ways of their inclusion in conventional heat-supply and ventilation schemes of metro stations. This takes into consideration standard technological equipment and parameters and volumes of thermal emissions [2]. At stage 2, optimization of the Brayton’s reverse cycle parameters is performed taking into consideration the limitations associated with thermal conditions of the main tunnel ventilation of the metro stations. Restrictions are imposed by requirements to the ventilation air parameters as well as the capabilities of the process equipment of ventilation systems (pressure level) and the values of efficiency factors of compressors and expanders [2]. Conditions of energy-efficient operation of AHPI are determined taking into consideration the so-called scale factor, the design heat output of the installation [3, 4]. Thermodynamic analysis is performed and exergy efficiency of each element and the whole installation is determined at stage 3. At stage 4, thermo-economic diagnostics and optimization of the adopted schematic solutions are performed. Recommendations for a thermo-economic optimization of the refrigerating machine cycles and corresponding methods are given in [5, 6].

Papers [2–4] are devoted to stages 1 and 2. It is relevant to consider stage 3 related to the development of schematic solutions for ARM and AHPI which should be devoted to in-depth thermodynamic analysis. It provides for a block-modular principle of ARM and AHPI calculation. The blocks contain equations describing thermodynamic properties of air, relationships for finding parameters of the working substance at the node points of the cycle, equations for calculating exergy flow and a block for statistical data processing.

2. Literature review and problem statement

Development of next-generation ARMs and AHPIs which can compete with vapor-compression machines is practically impossible without conducting in-depth thermodynamic analysis at the design stage. Such analysis can show what of the system elements is the main source of exergy losses taking into consideration nonequivalence and interrelations in the system. At the early stages of system development, thermodynamic analysis makes it possible to correct adopted technical solutions or reveal their lack of prospects. In the case of installation operation, it is capable to identify the scheme “problem elements” with a too high specific consumption of exergy.

In-depth thermodynamic analysis distinguishes exogenous and endogenous destruction of exergy in the transformer cycle [7–9]. Endogenous exergy destruction $E_{D,k}^{EN}$ is associated exclusively with imperfection of the k -th element of the scheme. Exogenous part of exergy destruction that occurs in the same k -th component depends on the presence of irreversibility in other components of the scheme.

Article [7] is devoted to analysis of $E_{D,k}^{EN}$ and $E_{D,k}^{EX}$ in refrigerating vapor-compression cycles. Using the principle of thermodynamic idealization of processes, authors of this

work have proposed a method for construction of so-called hybrid cycles. To find $E_{D,k}^{EN}$, it is assumed that all other processes except one under consideration in the hybrid cycle should be idealized. Disadvantage of the method of hybrid cycles is ignoring of the scheme structure. This method can identify $E_{D,k}^{EN}$ and $E_{D,k}^{EX}$ only in the main elements that affect configuration of the cycle. It is impossible to take into consideration influence of additional elements on the cycle. In complicated schemes containing, for example, a regenerative heat exchanger, an economizer, intermediate vessels and those using multiple throttling of the working substance, construction of hybrid cycles is problematic which complicates the process of finding $E_{D,k}^{EN}$ and $E_{D,k}^{EX}$.

In paper [8], authors proposed a so-called engineering method of finding $E_{D,k}^{EN}$ and $E_{D,k}^{EX}$ in gas-turbine and refrigeration cycles. To determine $E_{D,k}^{EN}$ and $E_{D,k}^{EX}$ regression analysis is used. Based on the results, a graphical dependence is constructed that shows how the change in exergy losses E_D^{other} in other elements of the scheme (with the exception of the element under consideration) affects total losses E_D^Σ in the system. Dependence $E_D^\Sigma = f(E_D^{other})$ is linear and described by regression equation $y = bx + c$ where $c \equiv E_{D,k}^{EN}$. To obtain dependence $E_D^\Sigma = f(E_D^{other})$, installation was calculated for certain varying defining parameter in the element. At the same time, the process parameter affecting the amount of exergy destruction in the component under consideration should vary every time. This requires a large number of multivariate calculations.

Given limited initial information on the degree of influence of the efficiency factor of each process on efficiency of the entire system, the following procedure for calculation of $E_{D,k}^{EN}$ or $E_{D,k}^{EX}$ was proposed in article [9].

To determine $E_{D,k}^{EN}$ and $E_{D,k}^{EX}$ dependences between the exergy efficiency factor of all elements of the refrigeration machine, the total losses E_D^Σ in the system and the losses in the remaining elements $E_D^\Sigma = E_D^\Sigma - E_{D,k}$ in the k -th component were obtained by the linear regression method. The remaining elements are understood as all main devices of the system except for the k -th element under consideration. Further, from the dependences obtained, values E_D^{other} were determined for the k -th element by fixing the values of all efficiency factors at varied E_D^Σ and linear dependences of E_D^Σ on E_D^{other} corresponding to the considered modes were constructed. Thus, the authors used the method of linear regression twice: first to derive dependence $E_D^{other} = f(E_D^\Sigma, \eta_k^{ex})$ and then to find coefficients of equation $E_D^\Sigma = bE_D^{other} + E_{D,k}^{EN}$ in each mode.

In general, assumption of constancy of the exergy efficiency factor of the element $\eta_k^{ex} = const$ in question in construction of the dependence $E_D^\Sigma = f(E_D^{other})$ is disadvantage of the engineering method. However, in reality, the exergy efficiency factors η_k^{ex} of the elements are interconnected by complex nonlinear dependencies.

An alternative approach to determination of endogenous and exogenous destruction of exergy based on the Valero and Lozano theory of exergy cost was considered in [10]. The theory of exergy cost [11] was developed for thermo-economic diagnostics of the energy-transforming system and revealing causes of additional resource consumption by the system due to inefficiency of any of its elements. The theory is based on general economic principles of representation of technical systems, such as resource, structure, efficiency and purpose. It takes into consideration nonequivalence and interdependence of exergy losses in each element, as well as the effect of losses on the total exergy consumption. To determine

$E_{D,k}^{EN}$ and $E_{D,k}^{EX}$ a thermo-economic model of the production structure including a set of relationships describing exergy transformation should be formed. This model serves as a basis for determining exergy losses associated with each flow and evaluating effectiveness of the entire system. The model reflects topology of exergy transformation processes and not the technical topology of the system itself. The production structure of the energy-transforming system is represented in a form of a functional scheme in which exergy flows at the input to and output from the element are classified according to the qualitative criterion “fuel” and “product”. The interrelation between the elements of the production structure is identified on the basis of their functional connection. To calculate exergy losses, a matrix form of recording exergy balances and a method of graphs for their solution are used. By determining the resource consumed by the element (its “fuel”), and singling out its “product” expressed through the exergy of the associated material or energy flows, it is possible to reveal additional consumption of “fuel” of the entire system caused by abnormal operation of a particular scheme element. The terminology that is used somewhat differs from the terminology of the hybrid cycle method. For example, instead of the endogenous and exogenous components of exergy destruction, concepts of anomaly and dysfunction are introduced. The anomaly (*an analogue of endogenous destruction*) is associated exclusively with the growth of the specific consumption of “fuel” in the element in question compared to the reference mode. Dysfunction (*an analogue of exogenous destruction*) is associated with the presence of anomalies in other elements which in turn cause a change in the “product” of the element in question.

In an earlier work [12] devoted to the development of a procedure of thermoeconomic diagnostics based on the theory of exergy cost, the authors determined only endogenous exergy destruction and so-called “structural” irreversibility. Developing further this approach, work [13] in determining dysfunction began to identify the portions of anomalies associated with inefficiency of other elements of the scheme. Despite this significant addition, the procedure of thermoeconomic diagnostics is not without its shortcomings. One of the “weaknesses” of the procedure is that the results entirely depend on the way of decomposition of exergy flows. Assigning the function “fuel” or its “product” to each flow of exergy is based in a number of cases on authors’ subjective ideas regarding the functional purpose of the scheme element. No clear rules for assigning “fuel” or “product” function to the flow were formulated. In many respects, the question of distribution of “remainders” [14], that is, those exergy flows for which the system’s exergy of “fuel” was expended but whose “product” (in a form of an increment of the flow exergy) is taken from the system to environment without its useful consumption remains controversial. To put it simply, the residual flow is the system’s “by-product” which is released into environment by means of a dissipating element (condenser, cooling tower, heat exchanger). It is stated in [14] that for simple closed cycles, distribution of costs connected with the residual flow must be proportional to the value of the entropy production value in each element. At the same time, for complex and open cycles, this should be done in a proportion to the value of each element exergy of “fuel”.

Formalization of the results of the exergy analysis, namely, translating them into a “practical plane”, also remains an open-ended question not solved in any of the approaches mentioned. Obviously, the subject field of applying results

of in-depth exergy analysis is a system of expert monitoring of installation efficiency. However, difficulties also appear largely related to the correct interpretation of the results and the question “what to do next with these results?” It is important to note that the exergy value itself (*specific consumption of exergy by an element*) is not a really controlled parameter. It cannot be measured as temperature, pressure or mass flow though it is defined by them. This is a manifesting property of a system, in other words, a system effect which depends on quality of the structural relationships between the components of a thermotransformer (of “hardness”) process scheme. Growth of exergy cost manifests itself as an additional consumption of system resources on compensation for an anomaly that arose in the element. To get competent recommendations on improvement of a thermotransformer scheme, it is necessary to connect the “fuel” exergy consumed by each element with a concrete parameter affecting efficiency of the process, e. g. isentropic efficiency factor of the compressor, temperature head in a heat exchanger, its hydraulic resistance, etc. It is impossible to establish such connection by analytical methods because of the multifactor nature of this problem. The only possible way to establish this relationship is statistical processing of multivariate calculations made by a thermo-economic model.

Thus, it can be stated that with the exception of the approach based on the exergy cost theory, all other approaches do not provide an integral picture of thermodynamic analysis. They are focused only on solution of a concrete partial problem of determining the exogenous and endogenous components of exergy destruction in an element. For a rational design of thermotransformation systems, it is also important to take into consideration the amount of the consumed drive energy of the system necessary to compensate for exergy destruction.

3. The aim and objectives of the study

This study objective was to develop a procedure for in-depth thermodynamic analysis of the ARM based on the exergy cost theory which will make it possible to take into consideration non-equivalence of exergy losses in various points of the thermotransformation process. Application of the exergy cost theory formalizes the process of building a thermo-economic model of the system enabling building of models of individual processes with a complex topology while reducing possible probability of subjective errors in the system development.

To achieve this goal, the following tasks were formulated:

- develop a parametric flow graph that equivalently reflects structural topology of the single-stage scheme of the ARM and its properties;
- perform a factor analysis of the effect of the isentropic efficiency factors of the turbocompressor and turboexpander and the ambient temperature on the exergy indicators of the ARM and obtain corresponding generalized dependences of indicators of exergy efficiency of elements and the system as a whole on variable factors.

4. The general principle of constructing a thermo-economic model of an air-compression refrigerating machine

To determine anomalies and dysfunctions in the system elements and exergy cost of the exergy flows, a comparative

analysis of two operating modes of the installation is necessary, i. e., reference and real modes. The real mode is characterized by the presence of anomalies in operation of the elements that arise during operation of the installation. As a reference mode, the mode obtained by the procedure of thermodynamic idealization of processes was chosen which involves elimination of technical exergy losses in the elements. The rules for eliminating technical losses during idealization of cycles were considered in [9]. According to the rules, when constructing an idealized reference cycle of the ARM, the values of the isentropic efficiency factors of the compressor and expander are assumed to be one. Also, the minimum temperature head in heat exchangers is excluded. An obligatory condition for the analysis is presence of the same “product” of installation (exergy cooling capacity) for both modes. To calculate air parameters in characteristic points of the cycle, recommendations of [15] were used. Exergy of flows were calculated by the procedure presented in [16].

Let us consider the main provisions of the procedure. When determining the exergy cost of each exergy flow taking into consideration recommendations of [17], distinguish the purpose of the flow coming in or outgoing from the k -th element by criterion “fuel F ” – “product P ”. For the scheme shown in Fig. 1, separation of exergy flows is shown in Table 1.

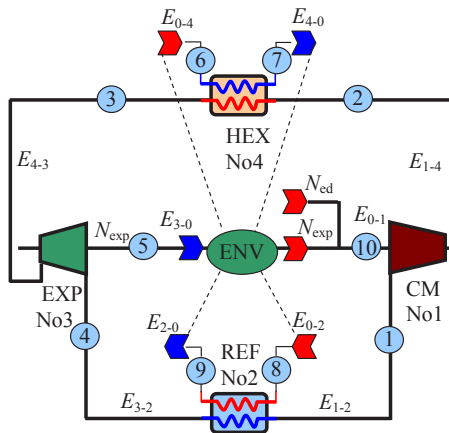

Fig. 1. Scheme of decomposition of exergy flows in the ARM

Fig. 1 shows the scheme of decomposition of exergy flows in the Brayton’s air-compression refrigerating machine. The following designations are used in the figure: CM for compressor; HEX for heat exchanger; EXP for turboexpander; REF for refrigerator; ENV for environment; No. 1–4 for the serial number of the element; E for exergy of flow, the first subscript denotes the number of the element from which E comes out, the second subscript denotes the number of the element into which E enters; E_{2-0} , E_{0-2} is air exergy at the inlet and outlet of the refrigerator; E_{0-4} , E_{4-0} is air exergy at the inlet and outlet of the heat exchanger; N_{ed} is power of the electric drive, supplied to the KM; N_{exp} is the power produced by EXP. The sum of N_{ed} and N_{exp} is the exergy flow E_{0-1} .

The equation of the exergy balance for the k -th element can be written as

$$F_k - P_k - R_k = E_{D,k}, \quad (1)$$

where F_k , P_k is “fuel” and “product” of the k -th element; $E_{D,k}$ is exergy destruction in the element; R_k is the “residue” flows. The products of dissipative elements are residual

flows. In the ARM scheme (Fig. 1), heat exchanger (HEX) is the dissipative element.

Table 1

Separation of exergy flows by the “fuel” and “product” principle for the Brayton’s air-compression refrigerating machine

Flow	E , kW	Output	F/P	Input	F/P
1	E_{2-1}	REF	F	CM	P
2	E_{1-4}	CM	P	HEX	F
3	E_{4-3}	HEX	F	EXP	F
4	E_{3-2}	EXP	F	REF	F
5	$N_{\tau a}$	EXP	P	ENV	F
6	E_{0-4}	ENV	P	HEX	P
7	E_{4-0}	HEX	P	ENV	F
8	E_{0-2}	ENV	P	REF	P
9	E_{2-0}	REF	P	ENV	F
10	$N_{ed} + N_{exp}$	ENV	P	CM	F

Fig. 2 shows the exergy flows entering the k -th element from the i -th elements ($i=1, 2, \dots, n$) and to/from environment. Also, Fig. 2 shows distribution of “residue” flows among those elements in which exergy was consumed for their production.

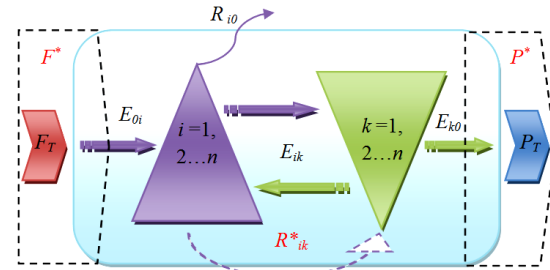

Fig. 2. A generalized diagram of the image of the target exergy flows in the installation

Proceeding from the scheme (Fig. 2), expression for the “fuel” flow of the k -th element can be written as

$$F_k = E_{0k} + \sum_i E_{ik},$$

where E_{0k} are the exergy flows entering the system from external sources; E_{ik} is exergy flows which are the “products” of other elements and enter the k -th element in a form of “fuel”. In this case, the flow with index i will be positive if it comes to the k -th element from the i -th element and negative if it leaves the k -th element and enters the i -th element (Fig. 2).

The “product” of the element is

$$P_k = E_{k0} + \sum_k E_{ki},$$

where E_{k0} is exergy flows which are a “product” for environment; E_{ki} is exergy flows emerging from the k -th element as “product” and entering the i -th element as “fuel”.

Specific consumption of exergy in an element is defined as the ratio of “fuel” to its “product”

$$k_k = \sum_{i=0}^n k_{ik} = F_k / P_k, \quad (2)$$

where

$$k_{ik} = \frac{E_{ik}}{P_k}$$

Since the analysis is performed by comparing reference and real modes, then writing equation (1) as

$$F_k - F_k^0 = (P_k - P_k^0) + (E_{D,k} - E_{D,k}^0) + (R_k - R_k^0), \tag{3}$$

fuel overconsumption can be determined in the k -th element. The superscript index “0” in (3) denotes the reference mode.

The change in exergy destruction in a real mode in comparison with the reference mode $\Delta E_{D,k} = (E_{D,k} - E_{D,k}^0)$ represents a removable component of the $E_{D,k}$ destruction since all losses in the reference mode are considered to be unrecoverable. In its turn, the removable component of exergy destruction is divided into endogenous and exogenous parts:

$$\Delta E_{D,k} = E_{D,k}^{EN} + E_{D,k}^{EX} = P_k^0 \Delta k_k + (k_k - 1) \Delta P_k.$$

Using the terminology of the exergy cost theory, the endogenous component of exergy destruction $E_{D,k}^{EN}$ will be henceforth called an anomaly in the element and determined by the formula

$$MF_k = P_k^0 \Delta k_k = \sum_{i=0}^n MF_{ik} = \sum_{i=0}^n \Delta k_{ik} P_k^0,$$

where Δk_{ik} is the change of specific consumption of exergy in the element compared to the reference mode; P_k^0 is the product of the element in the reference mode.

Exogenous component of exergy destruction $E_{D,k}^{EX}$ or a dysfunction is defined as

$$DF_k = \sum_{i=0}^n (k_{p,k}^* - 1) \Delta k_{ki} P_i^0,$$

where $k_{p,k}^*$ is the specific exergy value of the “product” of the k -th element which is determined taking into consideration the exergy cost of other elements $k_{p,i}^*$ ($i \neq k$) and also taking into consideration the exergy spent for production of the dissipative element product ρ_{ik} :

$$k_{p,k}^* = k_{0k} + \sum_{i=0}^n k_{p,i}^* (k_{ik} + \rho_{ik}). \tag{4}$$

If flow E_{ik} refers to the “product” of the i -th element, then according to the rule of exergy cost [10, 11] $k_{ik}^* = k_{p,i}^*$, where $k_{ik}^* = E_{ik}^* / E_{ik}$ is specific exergy cost which is equal to the exergy consumed by the element for production of 1 kW of its “product”, kW/kW; E_{ik}^* is exergy cost of flow E_{ik} .

In expression (4), ρ_{ik} defines the fraction of the residues of the i -th dissipative element in the cost of the k -th element [10]:

$$\rho_{ik} = \Psi_{ki} \cdot \frac{P_k}{P_i},$$

where

$$\Psi_{ki} = \frac{E_{ki}}{F_i}$$

is the ratio of the exergy flow entering the dissipative element to its “fuel”.

In this case, P_i is the product of the dissipative element and is equal to the amount of exergy R_{i0} , that is diverted

from the dissipative element to environment, F_i is “fuel” of the dissipative element.

The cost of the remainder distributed between the elements can be written as

$$R_{ki}^* = \Psi_{ki} \cdot R_{k0}^*.$$

Provided that the target products of the installation in the reference and real modes are equal ($\Delta P_T = 0$), the additional “fuel” consumption ΔF_T by installation can be expressed through MF and DF as

$$\Delta F_T = \sum_{k=1}^n \left(MF_k + \sum_{i=1}^n DF_{ki} \right) = \sum_{k=1}^n MF_k^*,$$

where MF_k^* is the cost of anomaly in the element (the system fuel consumptions for eliminating exergy losses in the element).

Thermo-economic diagnostics use the element’s productivity indicator [18]

$$f_k = \frac{MF_k^*}{\Delta F_T}.$$

Indicator f_k allows one to estimate additional consumption of the system’s “fuel” caused by appearance of an anomaly in the element.

5. Matrix form of recording the exergy balance

It is known that equation of the exergy balance (1) characterizes only presence of losses and does not reflect their interrelation in various elements of the scheme. Besides, the system “fuel” consumption to compensate for exergy losses can be larger or smaller than the losses themselves depending on the topology of the scheme, the exergy conversion “path length”.

In order to take into consideration influence of the structure of the process scheme, we use a matrix form of recording exergy balances [19]. Such an approach will largely allow us to overcome computational and methodological difficulties caused by the structure of the connections in the system and the problem dimension. The incidence matrix uniquely determines relationships in the elemental ARM structure and is, in fact, a mathematical model of the scheme structure topology. The number of units in each line gives localization of elements with separation or mixing of exergy flows, and the sign determines subordination of the flows to each element [20].

Let us carry out analysis of the exergy transformation using signal graphs that visually reflect the cause-effect relationships between the signals of a complex system. The values of exergy flows are considered here as the system signals [21].

For the computer representation of structural relationships, the ARM scheme (Fig. 1) can be represented as a directed graph $D=(V; L)$ consisting of a set of vertices V (ARM elements) and a set L of ordered pairs of vertices $i, k \in V$ (Fig. 3).

Circled numbers in Fig. 3 correspond to the numbers of vertices (equipment items) and the numbers near the arrows are ordered pairs of vertices (exergy flow).

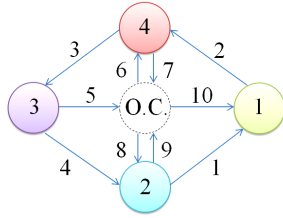

Fig. 3. The ARM scheme in a form of an oriented graph

Connections between the incident elements of the graph are represented by matrix A , then by a total input matrix in which rows correspond to the elements of the installation and the columns correspond to the mass flows and the work produced and consumed. The size of the matrix is 4×10 (4 main elements of the installation, and 10 mass flows and working interactions). The flow entering the element is $+1$, and the outgoing flow is -1 .

$$A = \begin{bmatrix} 1 & -1 & 0 & 0 & 0 & 0 & 0 & 0 & 0 & 0 & 1 \\ -1 & 0 & 0 & 1 & 0 & 0 & 0 & 1 & -1 & 0 & 0 \\ 0 & 0 & 1 & -1 & -1 & 0 & 0 & 0 & 0 & 0 & 0 \\ 0 & 1 & -1 & 0 & 0 & 1 & -1 & 0 & 0 & 0 & 0 \end{bmatrix}$$

Thus, the exergy balance can be written in the matrix form as

$$A \cdot E = E_D,$$

where E is a column that contains exergy of each mass flow and exergy of the heat and work flows. The term E_D is the required column vector, the elements of which characterize loss of exergy in a corresponding k -th element of the equipment.

Representation of the exergy balance in the “fuel” – “product” system can be represented as:

$$A = A_F - A_P - A_R;$$

$$A_F E = F; A_P E = P; A_R E = R.$$

Here A_F, A_P, A_R are the input matrixes of fuel, products, and residues; F, P, R are the column vectors containing exergies of fuel, products and residues, respectively.

For the considered ARM scheme, A_F, A_P, A_R are written as follows:

$$A_F = \begin{bmatrix} 0 & 0 & 0 & 0 & 0 & 0 & 0 & 0 & 0 & 0 & 1 \\ -1 & 0 & 0 & 1 & 0 & 0 & 0 & 0 & 0 & 0 & 0 \\ 0 & 0 & 1 & -1 & 0 & 0 & 0 & 0 & 0 & 0 & 0 \\ 0 & 1 & -1 & 0 & 0 & 0 & 0 & 0 & 0 & 0 & 0 \end{bmatrix},$$

$$A_P = \begin{bmatrix} -1 & 1 & 0 & 0 & 0 & 0 & 0 & 0 & 0 & 0 & 0 \\ 0 & 0 & 0 & 0 & 0 & 0 & 0 & 0 & 0 & 0 & 0 \\ 0 & 0 & 0 & 0 & 1 & 0 & 0 & 0 & 0 & 0 & 0 \\ 0 & 0 & 0 & 0 & 0 & -1 & 1 & 0 & 0 & 0 & 0 \end{bmatrix},$$

$$A_R = \begin{bmatrix} 0 & 0 & 0 & 0 & 0 & 0 & 0 & 0 & 0 & 0 & 0 \\ 0 & 0 & 0 & 0 & 0 & 0 & 0 & -1 & 1 & 0 & 0 \\ 0 & 0 & 0 & 0 & 0 & 0 & 0 & 0 & 0 & 0 & 0 \\ 0 & 0 & 0 & 0 & 0 & 0 & 0 & 0 & 0 & 0 & 0 \end{bmatrix}.$$

Following determining the input matrices, a diagonal matrix K_D can be constructed. It contains exergy consumption in each equipment element (2)

$$F = K_D P.$$

The main thesis of the exergy cost theory is that the exergy cost of any flow be it “fuel” or “product”, will be equal to the exergy spent for its production, i. e. $F^* = P^*$ (Fig. 2). Then this postulate can be written in a matrix form as

$$A \cdot E^* = 0,$$

where E^* is the required vector-column with its elements characterizing the exergy cost of the installation flows.

To determine E^* , the input matrix A must be supplemented with equations that would reflect the following factors:

1. Flows introduced to the installation and their exergy.
2. Presence of internal branches, i. e., presence of several element outputs connected to other equipment of the system.
3. Presence of residues that have zero exergy in the event that additional exergy is not spent for their elimination, and, if spent, it is a “negative” exergy.
4. Presence of by-products.

As a result, the system of equations for determination of E^* will have the form:

$$\Lambda E^* = \Omega, \tag{5}$$

where $\Lambda = [A | \alpha]$ is the square expanded input matrix consisting of an input A and an internal α matrices; Ω is a vector-column which includes the following elements: the exergy of the entrance, the exergy of the products, the exergy of the remnants.

For the considered ARM, the matrix size α is 6×10 , thus (5) is written as

$$\begin{bmatrix} 1 & -1 & 0 & 0 & 0 & 0 & 0 & 0 & 0 & 0 & 1 \\ -1 & 0 & 0 & 1 & 0 & 0 & 0 & 1 & -1 & 0 & 0 \\ 0 & 0 & 1 & -1 & -1 & 0 & 0 & 0 & 0 & 0 & 0 \\ 0 & 1 & -1 & 0 & 0 & 1 & -1 & 0 & 0 & 0 & 0 \\ 0 & 0 & 0 & 0 & 0 & 0 & 0 & 0 & 0 & 1 & 0 \\ 0 & 0 & 0 & 0 & 1 & 0 & 0 & 0 & 0 & 0 & 0 \\ 0 & 0 & 0 & 0 & 0 & 0 & 0 & -1 & 1 & 0 & 0 \\ 0 & 0 & 0 & 0 & 0 & 0 & -1 & 1 & 0 & 0 & 0 \\ -x_1 & 1 & 0 & 0 & 0 & 0 & 0 & 0 & 0 & 0 & 0 \\ 1 & 0 & 0 & -x_4 & 0 & 0 & 0 & 0 & 0 & 0 & 0 \end{bmatrix} \begin{bmatrix} E_1^* \\ E_2^* \\ E_3^* \\ E_4^* \\ E_5^* \\ E_6^* \\ E_7^* \\ E_8^* \\ E_9^* \\ E_{10}^* \end{bmatrix} = \begin{bmatrix} 0 \\ 0 \\ 0 \\ 0 \\ E_{10} \\ E_5 \\ E_{Q0} \\ 0 \\ 0 \\ 0 \end{bmatrix}.$$

Here, the exergy cost E_{10}^* is equal to the exergy of the input flow to the installation E_{10} installation (Fig. 1). The proportionality factors x_1 and x_4 were derived from the balance of the exergy cost of the flows, namely:

– for CM, the balance is written as $E_2^* - E_1^* = E_{10}^*$, hence, if the right-hand side of the equation is equate to zero, the following can be written:

$$x_1 = \frac{E_2^*}{E_1^*};$$

– for REF, the balance is written as $E_4^* - E_1^* = E_9^* - E_8^*$, and the difference in costs of the flows 9 and 8 is equal in this

equation to the exergy of the cold E_{Q0} . By analogy with the CM, the following can be written:

$$x_4 = \frac{E_1^*}{E_4^*}$$

The difference in flows 6 and 7 is the exergy of heat which is diverted from the dissipative element to the environment as a by-product (residue). In this case, its exergy cost is equated to 0 which is also taken into consideration in the Λ matrix.

Next, exergy values of “fuel”, “product” of elements and additional consumption of “fuel” by installation according to the above theory (Section 4) are found.

To implement the described algorithm, TAESS-circe software was used based on the method of graphs.

6. Results of numerical realization of the procedure of thermodynamic analysis of the ARM

Using the procedure of in-depth thermodynamic analysis, component distribution of fuel consumption by each ARM element was found. As can be seen from Fig. 4, with a change of η_{is}^{cm} and η_{is}^{exp} the nature of distribution of consumption in compressor varied significantly. It was found that DF dysfunction occurs only in the compressor with the major part being the anomalies of three components (28 % for the cooler; 65.2 % for the turbine and 5.9 % for the heat exchanger).

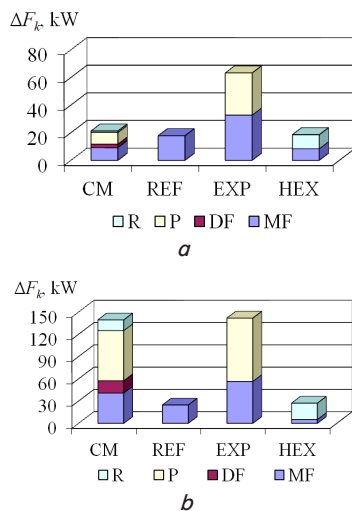

Fig. 4. The nature of distribution of exergy losses in the ARM elements when the isentropic efficiency of the compressor and the turboexpander vary: $\eta_{is}^{cm} = 0.95$, $\eta_{is}^{exp} = 0.875$ (a); $\eta_{is}^{cm} = 0.8$, $\eta_{is}^{exp} = 0.8$ (b)

Fig. 5 demonstrates effect of the isentropic efficiency factors of the expander η_{is}^{exp} and the compressor η_{is}^{cm} on consumption of exergy of “fuel” of the entire ΔF_T system.

Using the proposed algorithm, sensitivity of the ARM characteristics to the change in local system parameters was analyzed. This made it possible to reveal for some scheme elements the modes of their operation unfavorable in terms of exergy consumption.

Fig. 6 demonstrates the character of change of the turboexpander indicator f_{exp} as a function of η_{is}^{exp} and η_{is}^{cm} .

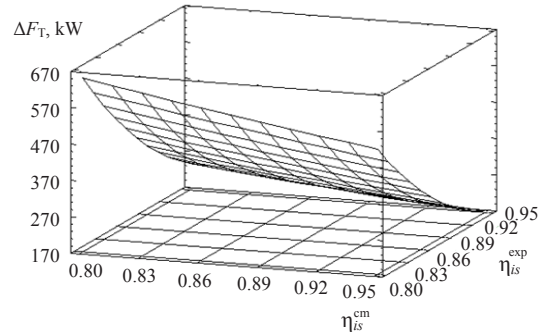

Fig. 5. Influence of η_{is}^{exp} and η_{is}^{cm} on ΔF_T

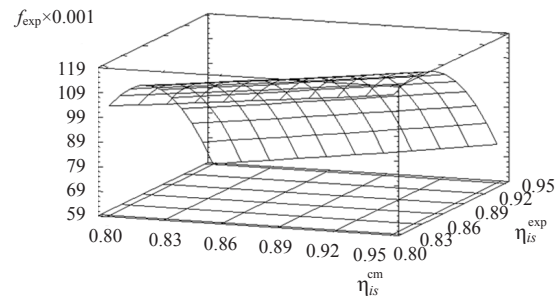

Fig. 6. Influence of η_{is}^{cm} and η_{is}^{exp} on f_{exp}

Fig. 7 demonstrates the character of change of indicator f_{cm} of the turbocompressor as a function of η_{is}^{exp} and η_{is}^{cm} .

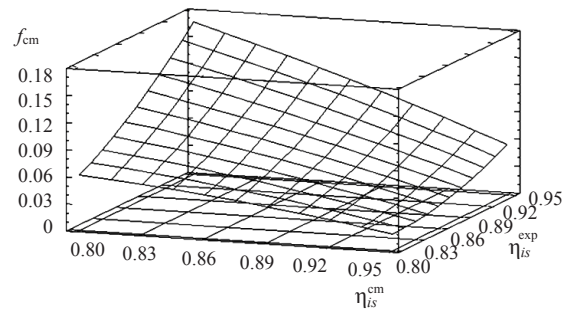

Fig. 7. Influence of η_{is}^{exp} and η_{is}^{cm} on f_{cm}

Fig. 8 demonstrates effect of the change of η_{is}^{exp} and η_{is}^{cm} on indicator f_{ref} .

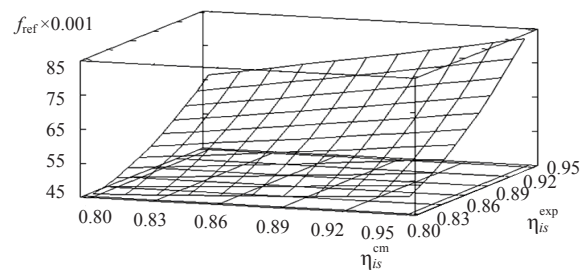

Fig. 8. Influence of η_{is}^{exp} and η_{is}^{cm} on f_{ref}

As can be seen from Fig. 6–8, there is a completely different character of change of indicator f for the ARM elements with a change of η_{is}^{exp} and η_{is}^{cm} . This indicates an essentially non-linear relationship between the cycle parameters.

Table 2 gives results of thermodynamic analysis of the ARM at various ambient temperatures: $T_{env} = 25^\circ\text{C}$ and $P_{env} = 0.1\text{ MPa}$ (variant a); $T_{env} = 30^\circ\text{C}$ and $P_{env} = 0.1\text{ MPa}$ (variant b)

Table 2
Change of the values of exergy flows “fuel” – “product” for two modes of the ARM operation

Element	Variant <i>a</i>			Variant <i>b</i>		
	<i>P</i> , kW	<i>F</i> , kW	<i>E_D</i> , kW	<i>P</i> , kW	<i>F</i> , kW	<i>E_D</i> , kW
CM	724.27	863.66	139.38	907.43	1066.00	179.57
REF	24.46	49.24	24.77	25.53	56.77	31/24
EXP	440.42	582.27	141.85	582.80	744.10	181.30
HEX	65.59	92.75	27.16	72.24	108.54	34.30

As can be seen from Table 2, with an increase in T_{env} , there is an average 13–20 % increase in consumption of the exergy of “fuel” by each element of the ARM.

7. Discussion of the results obtained in thermodynamic analysis of the air-compression refrigerating machine

The procedure of making in-depth thermodynamic analysis of the ARM developed on the basis of the exergy cost theory makes it possible to evaluate effectiveness of both individual elements and the whole scheme at various stages of system creation. To implement the procedure, an algorithm was proposed for constructing a thermo-economic model of the ARM which takes into consideration structural and topological features of the scheme and the relationship between its elements. The generalized dependencies of exergy indicators on variable factors obtained by numerical implementation of the procedure make it possible to identify unfavorable operating conditions for the ARM equipment with increased energy consumption. In constructing generalized dependencies, the apparatus of design an experiment was used which has made it possible to take into consideration the interrelated influence of variable factors on the installation performance.

Not taking into consideration the effect of pressure loss in the ARM heat exchangers is limitation of the proposed procedure. However, with a corresponding addition of the

calculation units, this drawback can be taken into consideration as well.

In terms of further development of this procedure, the problem of constructing a thermo-economic model for more complicated regenerative schemes and the ARM schemes implementing the Brayton's open-air cycle can be considered.

8. Conclusions

1. A parametric flow graph that equivalently reflects the structural topology of the single-stage ARM scheme and its properties was developed. This allowed us to apply the matrix approach of recording exergy balances which is necessary for automating the process of calculating the exergy destruction in the elements of complex schemes.

2. Anomalies and dysfunctions in each ARM element were revealed and their effect on consumption of the exergy of “fuel” for the entire system was established. The greatest influence on the change of consumption of the exergy of “fuel” of the system was exerted by the efficiency factor of the turboexpander. It was established that the CM co-opts dysfunctions of all other elements of the scheme while it is the most sensitive element to the change of exergy losses. Conservatism of REF to the change of exergy losses and their influence on consumption of the exergy of “fuel” was observed. Linear character of the change of consumption of the exergy of “fuel” was revealed for each element when ambient temperature varies. With an increase in T_{OC} from 25 °C to 30 °C, consumption of the exergy of “fuel” in the system increases by 19.6 % while the total destruction increases by 21.7 %.

Acknowledgement

This publication contains results of the conducted research funded by the grant of the President of Ukraine in the contest project F74/26150 and the studies conducted in the frames of the targeted research program; State registration number of the work is No. 0117U000875.

References

- Fialko, N. M. Ocenka effektivnosti primeneniya teplovykh nasosov v usloviyah metropolitenov i ugol'nyh shaht [Text] / N. M. Fialko, L. B. Zimin // Promyshlennaya teplotekhnika. – 2006. – Vol. 28, Issue 2. – P. 111–119.
- Kharlampidi D. Kh. K voprosu primeneniya vozdušnogo teplonasosnogo cikla Braytona dlya sistem teplohlosnabzheniya stancy metropolitenov [Text] / D. Kh. Kharlampidi, V. A. Tarasova // Energoberezhenie. Energetika. Energoaudit. – 2012. – Issue 4. – P. 40–48.
- Kharlampidi D. Kh. Primenenie vozdušnogo teplonasosnogo cikla Braytona dlya sistem teplohlosnabzheniya [Text] / D. Kh. Kharlampidi, V. A. Tarasova // Trudy XV mezhdunar. nauch.-tekhn. konf. «Sovershenstvovanie turboustanovok metodami matematicheskogo i fizicheskogo modelirovaniya». – Kharkiv: IPMash NANU, 2015.
- Kharlampidi D. Kh. Metodika termodinamicheskoy optimizatsii vozdušnogo teplonasosnogo cikla Braytona [Text] / D. Kh. Kharlampidi // Vestnik KGTU im. A. N. Tupoleva. – 2015. – Issue 4. – P. 98–106.
- Kharlampidi, D. Application of graphic apparatus of c-curves for the analysis and optimization of supercritical cycles of thermotransformers [Text] / D. Kharlampidi, V. Tarasova, M. Kuznetsov, S. Omelichkin // Eastern-European Journal of Enterprise Technologies. – 2016. – Vol. 5, Issue 8 (83). – P. 20–25. doi: 10.15587/1729-4061.2016.79988
- Kuznetsov, M. Thermo-economic optimization of supercritical refrigeration system with the refrigerant R744 (CO₂) [Text] / M. Kuznetsov, D. Kharlampidi, V. Tarasova, E. Voytenko // Eastern-European Journal of Enterprise Technologies. – 2016. – Vol. 6, Issue 8 (84). – P. 24–32. doi: 10.15587/1729-4061.2016.85397
- Morosuk, T. Advanced exergetic evaluation of refrigeration machines using different working fluids [Text] / T. Morosuk, G. Tsatsaronis // Energy. – 2009. – Vol. 34, Issue 12. – P. 2248–2258. doi: 10.1016/j.energy.2009.01.006

8. Kelly, S. Advanced exergetic analysis: Approaches for splitting the exergy destruction into endogenous and exogenous parts [Text] / S. Kelly, G. Tsatsaronis, T. Morosuk // *Energy*. – 2009. – Vol. 34, Issue 3. – P. 384–391. doi: 10.1016/j.energy.2008.12.007
9. Macevityy, Yu. M. Sistemno-strukturnyy analiz parokompressornyh termotransformatorov [Text] / Yu. M. Macevityy, E. G. Bratuta, D. Kh. Kharlampidi, V. A. Tarasova. – Kharkiv: Institut problem mashinostroeniya NAN Ukrainy, 2014. – 269 p.
10. Torres, C. Structural theory and thermoeconomic diagnosis [Text] / C. Torres, A. Valero, L. Serra, J. Royo // *Energy Conversion and Management*. – 2002. – Vol. 43, Issue 9-12. – P. 1503–1518. doi: 10.1016/s0196-8904(02)00032-8
11. Valero, A. Application of Thermoeconomics to Industrial Ecology [Text] / A. Valero, S. Us n, C. Torres, A. Valero // *Entropy*. – 2010. – Vol. 12, Issue 3. – P. 591–612. doi: 10.3390/e12030591
12. D'Accadia, M. D. Thermoeconomic analysis and diagnosis of a refrigeration plant [Text] / M. D. d'Accadia, F. de Rossi // *Energy Conversion and Management*. – 1998. – Vol. 39, Issue 12. – P. 1223–1232. doi: 10.1016/s0196-8904(98)00016-8
13. Piacentino, A. On Thermoeconomic Diagnosis of a Fouled Direct Expansion Coil: Effects of Induced Malfunctions on Quantitative Performance of the Diagnostic Technique [Text] / A. Piacentino, P. Catrini // *Journal of Sustainable Development of Energy, Water and Environment Systems*. – 2017. – Vol. 5, Issue 2. – P. 177–190. doi: 10.13044/j.sdewes.d5.0141
14. Torres, C. On the cost formation process of the residues [Text] / C. Torres, A. Valero, V. Rangel, A. Zaleta // *Energy*. – 2008. – Vol. 33, Issue 2. – P. 144–152. doi: 10.1016/j.energy.2007.06.007
15. Morozyuk, T. V. Teoriya holodil'nyh mashin i teplovyh nasosov [Text] / T. V. Morozyuk. – Odessa: Negociant, 2006. – 721 p.
16. Exergy: Energy, Environment And Sustainable Development [Text] / I. Dincer, M. A. Rosen (Eds.). – 2nd ed. – Elsevier Ltd., 2013. – 547 p.
17. Tsatsaronis, Dzh. Vzaimodeystvie termodinamiki i ekonomiki dlya minimizacii stoimosti energopreobrazuyushchey sistemy [Text] / Dzh. Tsatsaronis. – Odessa: Negociant, 2002. – 152 p.
18. Piacentino, A. Critical analysis of conventional thermoeconomic approaches to the diagnosis of multiple faults in air conditioning units: Capabilities, drawbacks and improvement directions. A case study for an air-cooled system with 120 kW capacity [Text] / A. Piacentino, M. Talamo // *International Journal of Refrigeration*. – 2013. – Vol. 36, Issue 1. – P. 24–44. doi: 10.1016/j.ijrefrig.2012.09.014
19. Boehm, R. F. Developments in the design of thermal systems [Text] / R. F. Boehm. – Cambridge University Press, 2005.
20. Chedzhne, F. Eksergoekonomicheskiy analiz sistem [Text] / F. Chedzhne, V. F. Flores, Dzh. K. Ordones, E. A. Botero // *Teploenergetika*. – 2001. – Issue 1. – P. 74–79.
21. Bobrov, D. A. Topologicheskii metod termoeconomicheskogo analiza slozhnyh energotekhnologicheskikh sistem [Text] / D. A. Bobrov, S. V. Cilin, V. V. Kafarov // *Teoreticheskie osnovy himicheskoy tekhnologii*. – 1985. – Vol. XIX, Issue 4. – P. 525–532.