

UDC 621.7; 621.8; 539.4

DOI: 10.15587/1729-4061.2018.126196

STUDY AND DEVELOPMENT OF THE TECHNOLOGY FOR HARDENING ROPE BLOCKS BY REELING

A. Dykha

Doctor of Technical Sciences, Professor, Head of Department
Department of wear resistance and reliability of machines
Khmelnyskyi National University
Instytutska str., 11, Khmelnytskyi, Ukraine, 29016
E-mail: tribosenator@gmail.com

D. Marchenko

PhD, Associate Professor*
E-mail: marchenkodd1984@gmail.com

V. Artyukh

Engineer*
E-mail: vitaliy5555555555@rambler.ru

O. Zubiekhina-Khaiiat

Engineer*
E-mail: zubehinakhayat@gmail.com

V. Kurepin

Engineer
Department of vocational training methods**

E-mail: kurepin@mnau.edu.ua
*Department of tractors and agricultural machinery,
operation and maintenance**

**Mykolaiv National Agrarian University
Georgiya Gongadze str., 9, Mykolayiv, Ukraine, 54020

Виконані дослідження глибини, ступеня наклепування і дифузії хімічних елементів поверхневого шару. Основним механізмом дифузії є градієнт щільності дислокацій. Досліджено процес зношування контактних поверхонь тертя при коченні з врахуванням проковзування. Запропоновані способи, технологія і пристрій для обкатування канатних блоків клиновим роликом, які забезпечують низьку шорсткість і високий ступінь наклепування поверхні

Ключові слова: контактна міцність, зношування, поверхнєве пластичне деформування, клиновий ролик, канатний блок

Выполнены исследования глубины, степени наклепа и диффузии химических элементов поверхностного слоя. Основным механизмом диффузии является градиент плотности дислокаций. Исследован процесс износа контактных поверхностей трения при качении с учетом проскальзывания. Предложены способ, технология и устройство для обкатывания канатных блоков клиновым роликом, которые обеспечивают низкую шероховатость и высокую степень наклепывания поверхности

Ключевые слова: контактная прочность, износ, поверхностное пластическое деформирование, клиновой ролик, канатный блок

1. Introduction

The problem of increasing wear resistance, contact strength and resistance to contact spalling is becoming increasingly relevant as intensity of handling equipment operation is constantly increasing. The most economical extension of the rope block service life is possible by improving properties of the surface layer. Surface properties can be controlled by changing the surface layer structure and physical and mechanical properties.

When operating equipment for general technical purposes, large-sized steel parts that perceive contact loads, such as cable blocks, tackle blocks, pulleys, etc. often fail. Significant work forces in the presence of misalignment of interconnected parts often bring about spalling and wear of the working friction surfaces, shape distortion, alteration of clearances between the parts. As a result, service life of handling equipment and machinery units in general is reduced. Numerous studies [1] have shown that up to 85 % of machine failures occur in operation not because of an insufficient structural strength of the parts and units but because of contact damage and wear of conjugated friction surfaces.

Application of thermal or thermochemical strengthening methods in the manufacture of large size rope blocks is limited by their dimension and weight. The most simple, available, and often solely possible, method for strengthening such blocks is surface processing by cold plastic working, namely reeling or hammering. To improve appearance and increase wear resistance of the surface layer, finishing surface plastic deformation (SPW) is applied and in order to increase fatigue strength and contact strength of parts, work hardening is used.

Therefore, the study of the effect of the reeled surface layer properties on tribotechnical characteristics is an urgent scientific and technical problem.

2. Literature review and problem statement

During operation of rope blocks, rope interacts with the surface of the block groove. Because of elastic deformation and torsion of the rope under load, it slips and rotates round its axis. This brings about various types of damage: the groove wear, appearance of cracks, collar spalling, general

deformations, and other flaws. A fundamental contribution to the theory, calculation, and design of a «rope block – rope» friction couple is made in [2, 3]. The proposed theoretical calculations in the design of the «rope block – rope» friction couple have low accuracy because of numerous simplifications and assumptions in the calculation method.

The issues of wear, study of surfaces subjected to contact loading as well as improvement of physical properties of surface layers are considered in [4–6]. These studies do not take into account the phenomenon of slippage of contact friction surfaces which in turn affects the mechanism of wear of the tribological couple.

Blocks are made of cast iron or steel by casting, pressing, or welding [7]. The use of cast iron for casting the blocks increases wear resistance of the block by 10–12 % compared to the steel blocks. Worn cast-iron (SCh 15-32) rope blocks are replaced by blocks of steel (25L) [8]. However, the proposed methods of hardening and restoring rope blocks, namely, restoration of the blocks with the help of automatic surfacing, welding, electromechanical processing, electroplating, etc. are very costly and of a low material-output ratio. Therefore, it is more advisable to take measures to harden the rope blocks and increase their longevity, especially with the help of SFW.

Consequently, many methods are effective for certain operation conditions (uniform loading, absence of abrasive wear, etc.) and ineffective [3] in other conditions (impact loads, large specific loads, abrasion, etc.). However, for a large number of enterprises, the equipment requiring quenching and cementation is economically unjustified and therefore the issue of techno-economic feasibility of its acquisition appears often.

When deciding on the expediency of hardening and restoration of parts, one should proceed from the technical feasibility of the enterprise in question. It is necessary to ensure performance of the part after its hardening and restoration for the entire inter-recouple service life of the unit encompassing this part and economic feasibility of hardening and restoration.

Solution of the tribo-contact problem for a friction couple was made on the basis of the wear model in [9]. The proposed solution is quite complex for practical implementation since it requires division of the wear area into discrete sections. It does not take into consideration technological features and the form of the contact friction couple.

Analysis of the change in contact pressure was made in [10] during wear of coating in a friction couple for a nonlinear form of the wearing law. As a wearing law, a dependence of the wear rate on speed and contact pressures was taken. A nonlinear Winkler model was adopted to describe deformation properties of contacting materials. The proposed algorithm for solution of the wear-contact problem of the friction couple will face significant difficulties in the case of loading the friction couple. This is determined by the problems of mathematical nature when using non-linear equations describing geometry of the contact couple in arbitrary equations.

Solution of an inverse wear contact problem for identifying parameters of the dependence of wear intensity on pressure and speed of sliding taking into account their distribution over the contact spot has been made in [11]. Based on the wear experiment by the «finger-disk» scheme, expressions for determining these parameters were obtained. However, assumption of stability of the wear spot accepted in

the work in accordance with the test scheme does not make it possible to use the obtained solution for the test schemes with a variable contact (wear) spot.

A study of wear of a working «rope block – rope» friction couple caused by difference in diameters is presented in [12]. It was established on the basis of this study that the difference between the radii of the rope and the rope block profile leads to a change in distribution of contact pressures, and a phenomenon of axial slippage of the rope occurs which in turn leads to wear of the contact friction surfaces. However, the article does not present the dependence on quality of processing the friction surfaces of the «rope block – rope» couple.

The mechanism of wear of the «rope block – rope» friction couple and distribution of residual stresses in the substrate surface were studied in [13]. The results of this study indicate that the rate of wear of the alloyed steel depends on diameter of the rope wires. The mechanism of wear of annealed low-alloy steel is characterized by fatigue and abrasive wear but the wire demonstrates partial adhesion because of microabrasive wear when a fatigue crack appears. Distribution of the residual stress contacts does not depend on the motion speed. Therefore, there are constant values in the contact surface.

Analysis of the nature of failure of the parts that wear from the contact load of the friction surfaces showed that failure of rope blocks begins mostly in the surface layer and the resistance to this failure is determined by quality of the surface layer. Therefore, it is possible to influence quality of the surface layer by changing methods of surface treatment to provide predefined tribological characteristics to the friction surfaces.

To solve these problems, there is a need for a comprehensive study of new technological processes and the use of advanced methods of SFW. The study of wear processes and development of a strengthening technology require the use of laws and methods of continuous medium mechanics, mathematical and applied theory of plasticity, as well as the phenomenological theory of deformability.

Thus, further theoretical and experimental studies of physical and mechanical properties of the surface layer and microstructural studies of steel specimens after reeling them with rollers are needed. It is necessary to investigate diffusion of chemical elements in the surface layer during surface deformation by means of microchemical analysis and carry out tribological studies of wear of contact friction surfaces during reeling with allowance for slippage. All these measures will make it possible to create a method, a process, and a device for strengthening the rope blocks by reeling and solve production problems during its implementation.

3. The aim and objectives of the study

The study objective was to develop a process and a device for strengthening rope blocks by reeling with a wedge roller based on physical-mechanical and tribological studies of the «rope block – rope» friction couple, which will increase their wear resistance and contact durability.

To achieve this objective, the following tasks were addressed:

- to conduct study of physical and mechanical properties of the surface layer and microstructure examination of steel specimens subjected to reeling;

– to study diffusion of chemical elements in the surface layer in the course of surface deformation by means of microchemical analysis and investigate the process of wear of contact friction surfaces during reeling with allowance for slippage;

– to develop a method and a technology of reeling friction surfaces of large-sized steel parts and carry out experimental studies of efficiency of the reeling technology for roughness and the degree of work hardening of the working friction surface of the parts.

4. Materials and methods used in the tribological study of the effect of reeling parts on the contact strength

Electron microscopy studies were carried out using a UEMV-100K microscope on thin foils prepared from the specimens taken at various distances from the surface and then thinned to a thickness transparent for electrons.

Depth and degree of work hardening during plastic deformation of the surface layer were estimated using the regression analysis method. To this end, rupture tests were conducted on 0.2...0.4 mm thick flat specimens cut from a part at various distances from the part surface with the help of Shovenar machine with film recording of specimen deformation versus load diagrams.

The study of the degree of hardening with analysis of the change of microhardness and diffusion of chemical elements in the surface layer in the process of SFW was carried out as follows.

Microhardness after reeling the specimens in various conditions was determined using the PMT-3 microhardness meter. Determination of microstructure was carried out with the help of the KMT-1 device. Investigation of chemical distribution of strengthening elements by means of microchemical analysis was carried out on a raster electron microscope with the Superprobe-733 micro-X-ray micro-chemical analyzer from Jeol Company (Japan).

The study of pressure on the surface of plastic contact of the roller with the part during work hardening was carried out on 6.4 mm thick models prepared of an optically sensitive material ED6-M with the PPU-4 polarization installation (Russia).

The TRB-S-DE tribometer (Switzerland) was used in the study of wear of the contact friction surfaces during reeling taking into consideration slippage to determine tribotechnical characteristics of the «disk-sphere» friction couple and the MI wear machine was used for modeling slippage with its upper shaft rotatable to ensure transverse slip. The VLR-200 (Russia) laboratory scale was used to measure weight loss in specimens.

Experimental studies of the technological process of hardening the rope block surface by reeling were carried out on a universal 1K65 screw-cutting machine. The technological process was recorded on Panasonic SDR-S26 video camera with a subsequent frame-by-frame examination. Force on the roller varied within

±5 % since the friction force of the rolling bearings was not more than 0.008. This provided a uniform deformation of the surface layer in the rope block groove.

The degree of work hardening was measured and determined after reeling with the help of TIME Hardness Tester TH130 (India) universal integral dynamic hardness meter.

Roughness of the rope block working surface before reeling was measured using reference roughness comparison specimens OSh (GOST 9378-93 made in accordance with requirements of GOST 2789-73). After reeling, roughness was measured with the help of replicas prepared from self-curing Protacril-M plastic using the profilographer-profilometer of A1 type (GOST 19299-73 and GOST 19300-73), model 252 manufactured by Caliber Enterprise (Russia).

The reeled rope blocks were tested for spalling with ropes in production conditions on KRUPP ship reloaders (Germany) with a hoisting capacity of 40 tons, MGZ OJSC, and KS-3575 autocranes with a hoisting capacity of 10 tons, Mykolayivbudmekhanizatsiya JSC (Ukraine).

5. Results of tribological tests and process parameters of reeling steel parts with rollers

Vickers hardness under force of 0.10 kN and mechanical characteristics σ_B , $\sigma_{0.2}$ and δ were determined on specimens taken from a shaft made of 40 grade steel and reeled under a reeling force of 50.0 kN (Fig. 1).

Statistical estimation of accuracy in determining the depth of work hardening was made proceeding from the changes in hardness HV_{10} and the yield strength of the work hardened metal layer.

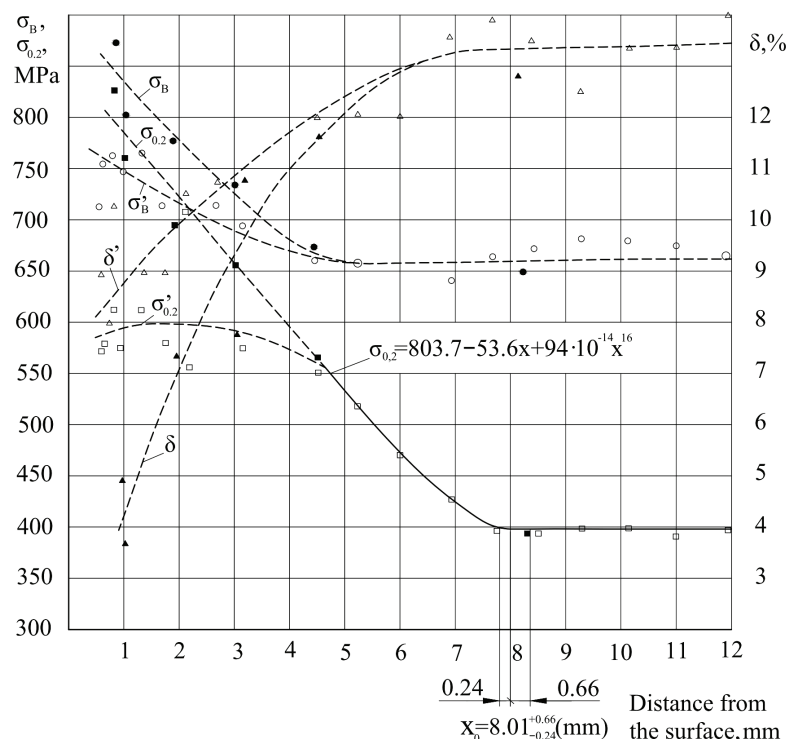

Fig. 1. Mechanical properties of the surface layer of the shafts reeled with toroidal rollers with diameter $D_p = 105$ mm, profile radius $r_p = 10$ mm: σ_B , $\sigma_{0.2}$ and δ are properties in a circular direction; σ'_B , $\sigma'_{0.2}$, δ' are properties in the axial direction

A hypothesis of normality of distribution of measurements of initial hardness and yield strength was verified by the Kolmogorov criterion. After that, the results of hardness tests were statistically analyzed by the small specimen technique.

Nonlinear regression analysis was used to determine the depth of work hardening (estimated by the start of change in mechanical properties $HV10$ and $\sigma_{0.2}$ of the deformed layer) and estimate accuracy of determining the depth of work hardening.

To describe the regression lines, the functions were taken [1]:

$$y = a_1 + b_1x + b_2x^m \quad (1)$$

and

$$y = a_1 + b_1x + b_2 \lg x, \quad (2)$$

where y is hardness or yield strength; x is the distance of the measuring point from the reeled surface.

Statistical processing of the results obtained in determining the coefficients a_1 , b_1 , b_2 in the regression equations was performed according to the least squares method. Dispersion coefficients, work hardening depth and its confidence intervals and the standard deviation were estimated as well.

In the process of the regression analysis, the values of coefficients of the regression equations (1), (2) and the abscissa of the extremum point were initially calculated taking into account the values of mechanical properties which differed significantly from the initial ones. After the points of measuring initial mechanical properties were shifted in the direction of the x -axis, up to coincidence of their abscissas with the abscissa of the extremum point of the regression line, solution was performed again, but with taking into consideration measurements of the initial mechanical properties altered in this way.

The solution was repeated until the difference between abscissas of the points of extremum of two last regression lines did not exceed a specified number equal to 0.01 mm. Calculations were carried out on a PC. Coefficient m of the parabolic regression line acquired values from 2 to 25.

The line having smallest residual dispersion S^2 was selected from various regression lines. The best regression line has appeared to be a parabolic dependence. For all tested specimens, the hypothesis of equality of mean values of work hardening depth determined by the results of measuring hardness and yield strength checked by the Student's criterion was not confirmed.

The study results have shown that yield strength of the work hardened layer increased to a greater extent than hardness (100–130 % versus 20–60 %). Due to this, the boundary of the work hardened layer was more clearly defined by the change in the yield strength. Use of cylindrical needle rollers of a small diameter leads to a sharp increase in the deformation ratio in a thin surface layer which was indicated by grain elongation in the direction of reeling seen in the optical microphotographs.

Accuracy of determining boundary of the work hardened layer by regression analysis according to the results of measurement of yield strength is twice as high in comparison with those obtained in Vickers hardness tests. The 95 % confidence intervals for the work hardening depth calculated

from the results of measurement of yield strength make up 11–36 % of the work hardening depth and 32–75 % for the hardness tests. The depth of work hardening which is determined by variations in the yield strength was 25–50 % more than the depth determined by Vickers hardness tests. This difference increases with a decrease in the degree of work hardening. The depth of work hardening determined according to the values of yield strength for circular and close to them imprints ($b/a \leq 2$) corresponded to that calculated by Heifets method even with a rather small reduced curvature of the contact between the roller and the part ($k=0.0835 \text{ mm}^{-1}$). It has been established that the yield strength was a more sensitive mechanical characteristic for determining the depth of plastic deformation than hardness. The depth of penetration of compressive stresses was close to the depth of work hardening determined by the yield strength.

Influence of conditions of reeling with rollers on the change of microstructure of the worked metal was studied in reeling with cylindrical and toroidal rollers of small diameter. Microstructure of the specimens prior to surface work hardening consists of pearlite grains surrounded by hypo-eutectoid ferrite (Fig. 2, *a*).

After reeling, changes in the microstructure observed on optical-digital microphotographs could only be found in the surface layers of the shaft reeled with a roller (Fig. 2, *b*). The changes were seen as a considerable elongation of both ferrite and perlite grains in a circular direction of reeling. It was established that at the distance from the surface (16.42 mm), the ferrite plates of perlite did not contain dislocations. In some locations, there were isolated dislocations in the ferrite-cementite interface. Ferrite grains in the specimens were constrained by flat straight boundaries. Inside the grains, there was a three-dimensional net of low density dislocations.

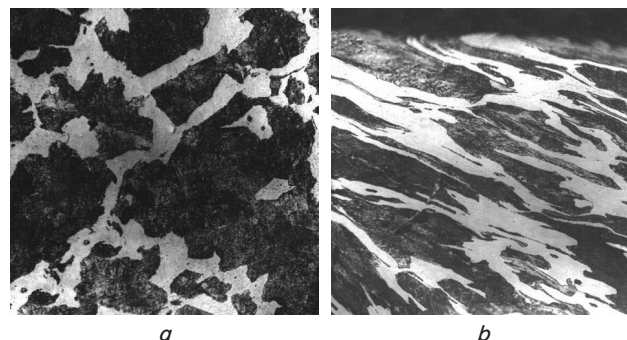

Fig. 2. Microstructure of specimens of the surface layer of normalized 40 grade steel: before reeling (*a*); after reeling (*b*) ($\times 300$)

As the electron-diffraction examination has shown, strengthening of the surface layers during reeling shafts with a roller was mainly due to emergence of dislocation cells in the structure of the excessive ferrite grains. Higher degree of work hardening when reeling with a needle roller manifested itself by a higher density of dislocations and a reduced size of cells in the substructure of ferrite grains and a thicker grid of dislocations in the ferrite plates of perlite. In some locations, bend and fracture of cementite plates was observed which indicated the limit degree of plastic deformation of the surface layer. This was confirmed by the beginning of peeling of the surface reeled with a five-millimeter roller.

Distribution of microhardness H_{μ} in the depth of three specimens is shown in Fig. 3.

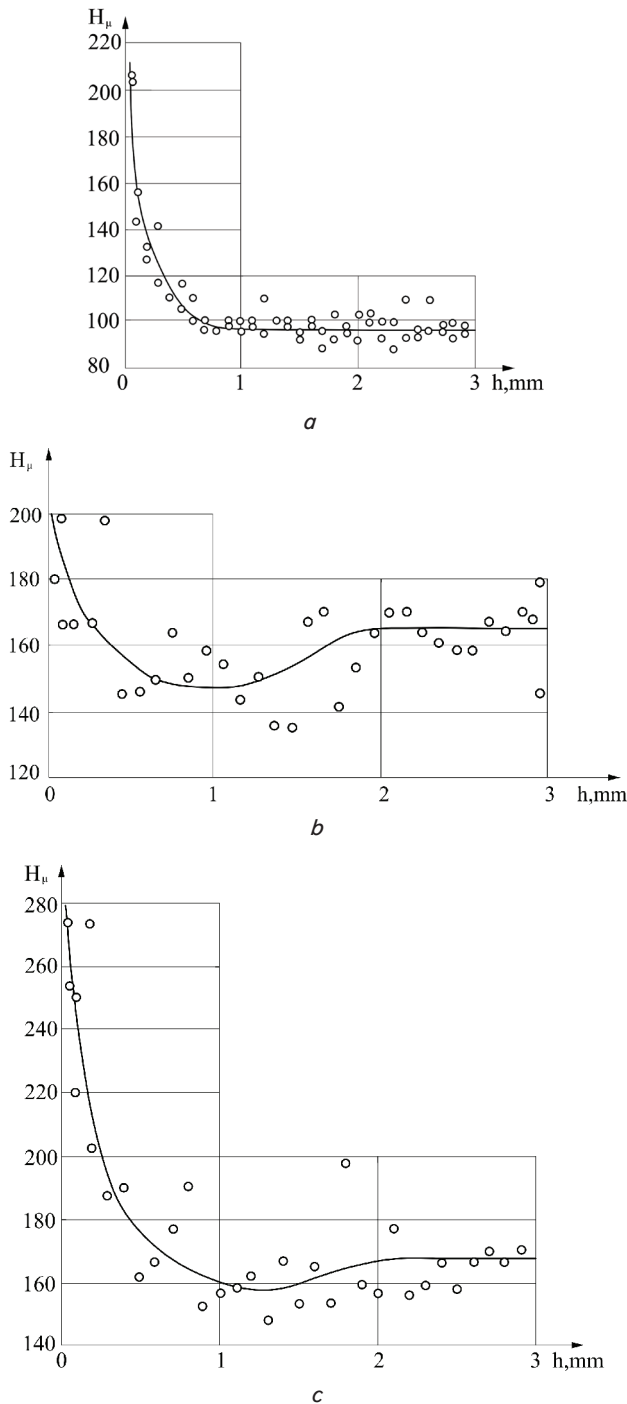

Fig. 3. Distribution of microhardness in the depth of the hardened layer: Armco iron, $r_p=2.5$ mm, $P=1.5$ kN (a); 45 grade steel, $r_p=5$ mm, $P=5$ kN (b); 40X grade steel, $r_p=2.5$ mm, $P=5.5$ kN (c)

In the graphs of Fig. 3, b, c for the specimens of 45 grade and 40X grade steel, a decrease in microhardness $H_{\mu(t.z.)}$ in the transition zone between the hardened layer and the initial metal with microhardness $H_{\mu(i.)}$ was found. The average values of $H_{\mu(t.z.)}$ and $H_{\mu(i.)}$ of normally distributed values were compared with the help of t , the Student criterion.

For this purpose, the reduced variance was determined:

$$S^2 = \frac{(n_1 - 1)S_1^2 + (n_2 - 1)S_2^2}{n_1 + n_2 - 2} \tag{3}$$

and

$$t = \frac{\bar{x}_1 - \bar{x}_2}{S \sqrt{\frac{1}{n_1} + \frac{1}{n_2}}}, \tag{4}$$

where n_1, n_2 is the number of measurements of H_{μ} in the transition zone and in the initial metal, respectively; S_1^2, S_2^2 is dispersion of $H_{\mu(t.z.)}$ and $H_{\mu(i.)}$ values, respectively; \bar{x}_1, \bar{x}_2 is the mean value of $H_{\mu(t.z.)}$ and $H_{\mu(i.)}$, respectively.

If $|t| \geq t_{\alpha}, K$, then difference between mean values is significant. The value of the confidence probability was taken equal to 0.95, ($\alpha=0.05$), the number of degrees of freedom was determined from the expression $K = n_1 + n_2 - 2$.

It was established that the content of Cr and C in the transition zone decreased by 20–30 % and increased to 10–15 % in the hardened layer. In reeling 40X grade steel and 45 grade steel, a significant reduction of microhardness was observed in the transition zone between the hardened layer and the initial metal. When Armco iron was reeled, such decrease was not detected (Fig. 3, a). Based on these studies, a hypothesis of diffusion of strengthening chemical elements (Cr, C) from the intermediate layer to the part surface was advanced. The main mechanism of diffusion during SFW was the gradient of dislocation density.

The method of photoelasticity has shown that during elastoplastic deformations, stresses in the surface of contact of the roller with the part were distributed along a curve close to elliptic, the difference was not more than 7 %.

It was established that when slippage was up to 2 %, a sharp change in the coefficient of friction could be observed after which it remained practically constant due to the spread of slippage over the entire contact area: an obvious dependence of the value of the maximum friction coefficient on the state of the friction surface. For example, in the process of abrupt change of the coefficient of friction for hardened and not hardened specimens, with lubrication and without it, the zone (crosshatched area) was detected when running-in was achieved faster for the specimens reeled with rollers (Fig. 4, a). It can be stated that the surface roughness only affects at small slips (up to 3 %) while reeling with rollers creates specified tribotechnical properties with reduced wear indicators in the surface layer.

Fig. 4, b shows dependence of the coefficient of friction on the surface roughness for the specimens before reeling and after reeling with a roller and Torsiol-55 lubricant applied. It was established that with a decrease in surface roughness after reeling with rollers, lubricated specimens had a decreased coefficient of friction.

When reeling with slippage, the main mechanisms of wear were oxidizing and fatigue (spalling) wear [14, 15]. Spalling deformation increased with an increase in slippage if tangential stresses were sufficiently large.

A procedure for determining the force of reeling with a wedge roller was developed. In order to prevent excessive work hardening and peeling of the reeled metal, a limitation for the reeling force at an average angle of indentation not more than 5° was introduced. With the help of nomogram, rolling force was determined as dependent on the size of

the part and the round roller and the reduced profile radius of the roller were chosen to determine the design parameters.

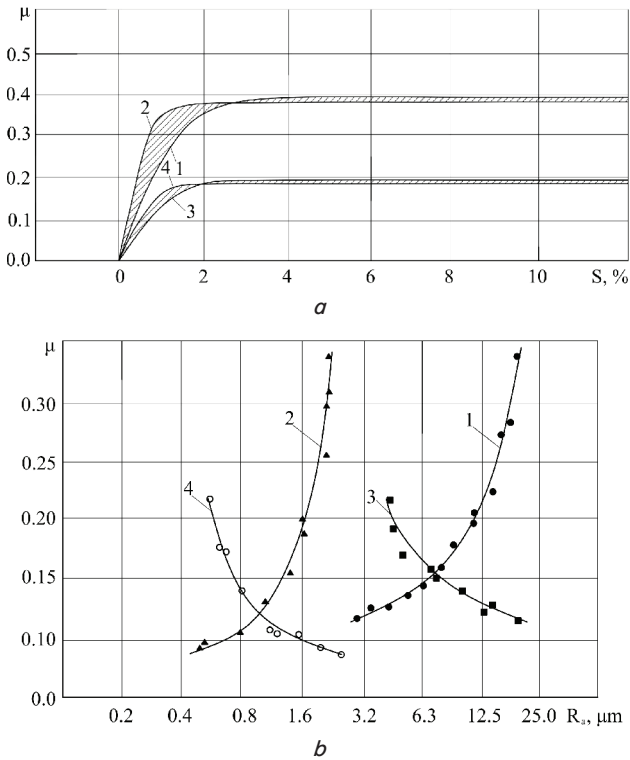

Fig. 4. Dependence of the coefficient of friction: on the magnitude of slip (a); on the surface roughness (b): non-reeled nonlubricated specimen (1); the nonlubricated specimen reeled with a roller (2); the non-reeled lubricated specimen (3); the lubricated specimen reeled with a roller (4)

The method of reeling steel parts [16] was developed and a theoretical analysis of geometrical parameters was made for reeling the rope blocks with a wedge roller.

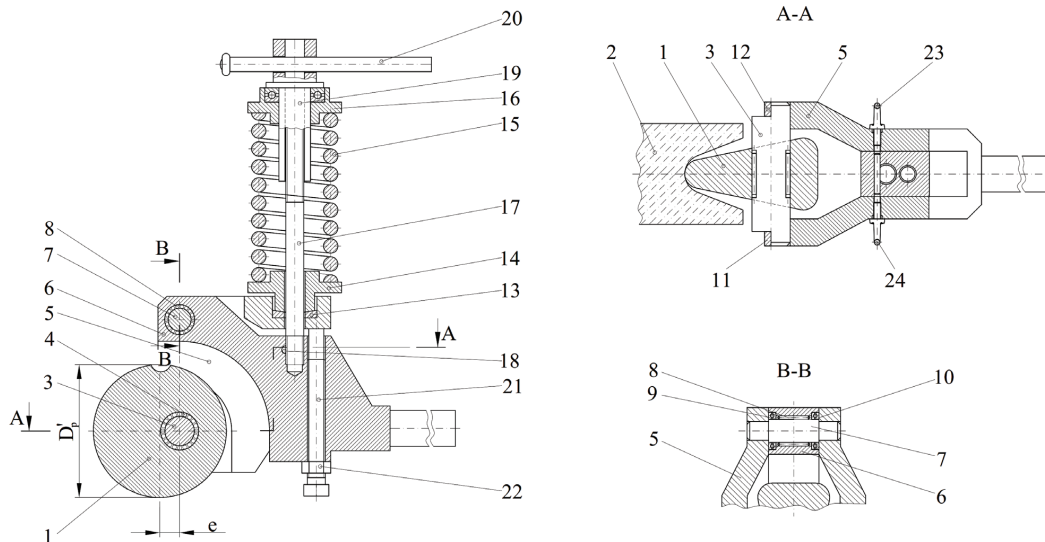

Fig. 5. The device for reeling rope blocks with a wedge roller: roller (1); reeled part (2); shaft (3, 7); bearings (4, 8, 9, 10); lever (5); bracket (6); plates (11, 12); spherical washer (13); sleeve (14); spring (15); sleeve (16); pulling rod (17); pin (18); nuts (19, 22); handle (20); screw (21); eye bolts (23, 24)

beating, eccentricity and diameter of the roller, its curvature, curvature of the reeled part and normal strengthening between the roller and the part in the deformation zone at all points of the profile were calculated.

Calculations have shown that in order to prevent formation of waviness on the reeled surface, the profile radius r_p is made of a variable value which ensures constancy of the angle $\varphi = 5^\circ$ of the roller indentation in all sections of the part profile.

The design of the device for reeling the rope blocks is shown in Fig. 5. It was patented and invention patents were granted [16, 17].

The developed device and technology of reeling [17] the rope blocks by a wedge roller provide low roughness and a high degree of surface work hardening. This effect is achieved by maintaining constant the average angle φ of the roller indentation into the surface to be worked and mounting of the roller unit on the rolling bearings. This contributes to a uniform deformation of the surface layer in absence of waviness and leads to an increase in durability of the workpiece.

In the course of the experimental study, estimation of dependence of performance of the reeling process on the angle of indentation of the roller, profile radius of the roller, reeling speed and the number of revolutions of the rope block was made.

When plotting the diagram, factors were applied on the abscissa axis in an order of decreasing their rank and the sum of the ranks for the corresponding factor was applied on the ordinate axis. With the help of the obtained diagram, an assessment of significance of the factors was made. To determine the factors that do not influence the technological process, the Student criterion (t criterion) was used.

After analysis and rejection of the mentioned minor factors, a classical diagram of the ranks with a decrease in their magnitude depending on the influence of the factor on the quality of realization of the technological process was constructed. The check of significance of the expert opinions consisted in election of 10 experts, with the number of factors in the matrix being 12 and the number of degrees of freedom $f = 11$.

Analysis of expert opinions («psychological experiment») and statistical processing have allowed us to conclude on the impact on the course and quality of implementation of the technological process. The four factors had the most affect: roller profile radius X_1 , mm; speed of reeling X_2 , m/min; angle of the roller indentation X_3 , degrees; number of the rope block revolutions X_4 , rev. The three-level, four-factor Box plan of the second order was used.

After statistical processing of the experimental data on a PC with the help of Statistica and Excel programs, mathematical models were obtained. These models were obtained for surface roughness (SR) and hardening degree (HD) which describe the technological process of reeling the rope blocks using a wedge roller device.

The regression equations take the form:

$$SR = 1.9224 - 0.2789 \cdot X_1 + 0.2520 \cdot X_2 - 0.5837 \cdot X_3 - 0.4970 \cdot X_4 - 0.014 \cdot X_1 \cdot X_2 + 0.280 \cdot X_1 \cdot X_3 - 0.002 \cdot X_1 \cdot X_4 - 0.154 \cdot X_2 \cdot X_3 + 0.257 \cdot X_2 \cdot X_4 + 0.359 \cdot X_3 \cdot X_4 - 0.094 \cdot X_1^2 - 0.522 \cdot X_2^2 + 1.405 \cdot X_3^2 - 1.280 \cdot X_4^2; \tag{5}$$

$$HD = 47.5008 - 0.2578 \cdot X_1 - 0.7167 \cdot X_2 + 0.135 \cdot X_3 + 0.1157 \cdot X_4 - 0.127 \cdot X_1 \cdot X_2 + 0.236 \cdot X_1 \cdot X_3 - 0.535 \cdot X_1 \cdot X_4 - 0.124 \cdot X_2 \cdot X_3 + 0.115 \cdot X_2 \cdot X_4 - 1.062 \cdot X_3 \cdot X_4 - 0.483 \cdot X_1^2 - 0.106 \cdot X_2^2 - 0.925 \cdot X_3^2 + 0.931 \cdot X_4^2. \tag{6}$$

After statistical processing, analysis of the obtained regression equations was made with encoded values of factors (Table 1). Study of optimization criteria depending on the change of independent factors was carried out using the method of two-dimensional sections.

Table 1

Data of encoding the test results

Indicator	-1	0	1
X_1 – The roller profile radius, mm	10	15	20
X_2 – Speed of reeling, m/min.	20	50	80
X_3 – Angle of roller indentation, deg.	2.5	5	7.5
X_4 – Number of the rope block revolutions, rev.	100	200	300

The mathematical models were checked for the rope blocks made of steel. When analyzing the values of coefficients at factors in the regression equation (5), a conclusion can be drawn that the process quality is most influenced by the angle of roller indentation (X_3) and the number of revolutions of the rope block (X_4). Similarly, it can be seen from equation (6) that the most important are the roller profile radius (X_1) and the speed of reeling (X_2). For a more thorough study of the process, an analysis of possible combinations of pairwise combination of factors was made.

Two factors were equalized in turn to zero leaving the other two unequal to the target value. Regression equation for surface roughness and the degree of hardening at possible combinations of factors was obtained.

Equating to zero the value of the angle of roller indentation (X_3) and the number of revolutions of the rope block (X_4), regression equations were obtained in the form:

$$SR = 1.9224 - 0.2789 \cdot X_1 + 0.2520 \cdot X_2 - 0.014 \cdot X_1 \cdot X_2 - 0.094 \cdot X_1^2 - 0.522 \cdot X_2^2; \tag{7}$$

$$HD = 47.5008 - 0.2578 \cdot X_1 - 0.7167 \cdot X_2 - 0.127 \cdot X_1 \cdot X_2 - 0.483 \cdot X_1^2 - 0.106 \cdot X_2^2. \tag{8}$$

Let us take partial X_1 and X_2 derivatives and obtain a system of equations for each of the optimization criteria:

$$\begin{cases} \frac{\partial SR}{\partial X_1} = -0.0144 \cdot X_2 - 0.1886 \cdot X_1 - 0.2789 = 0; \\ \frac{\partial SR}{\partial X_2} = -1.0452 \cdot X_2 - 0.01440 \cdot X_1 + 0.25204 = 0. \end{cases} \tag{9}$$

$$\begin{cases} \frac{\partial HD}{\partial X_1} = -0.12771 \cdot X_2 - 0.96658 \cdot X_1 - 0.25778 = 0; \\ \frac{\partial HD}{\partial X_2} = -0.21326 \cdot X_2 - 0.12771 \cdot X_1 - 0.71667 = 0. \end{cases} \tag{10}$$

After solving the system of equations by each of the mathematical models, coordinates of the centers of surface response were determined for each of the optimization criteria and the value of the target function in the found Y_S center.

The angle of rotation of the axes in the origin of coordinates of the mathematical model was determined in a canonical form by formula:

$$\arctg 2\alpha = \frac{B_{12}}{B_{11} - B_{22}}. \tag{11}$$

Coordinates of response of the surface centers were calculated:

– for the surface roughness: $X_1 = -1.49$; $X_2 = 0.26$; $\alpha = -0.96^\circ$; $Y_S = 2.16$;

– for the degree of hardening: $X_1 = 0.19$; $X_2 = -3.47$; $\alpha = 9.36^\circ$; $Y_S = 48.72$.

Coefficients of the regression equations of the characteristic equations for each of the optimization criteria were determined in a canonical form:

$$f(\lambda) = \begin{vmatrix} B_{11} - \lambda & B_{12}/2 \\ B_{21}/2 & B_{22} - \lambda \end{vmatrix} = 0, \tag{12}$$

to that end, the equations were reduced to the form:

$$\lambda^2 - I \cdot \lambda + D = 0. \tag{13}$$

Roots of this equation are the coefficients of a mathematical model in a canonical form. After the calculations, the regression equations were obtained in a canonical form:

– for the surface roughness:

$$SR - 2.164 = -0.094 \cdot X_1^2 - 0.522 \cdot X_2^2, \tag{14}$$

– for the degree of hardening:

$$HD - 48.7 = -0.096 \cdot X_1^2 - 0.493 \cdot X_2^2. \tag{15}$$

The results obtained by combining the X_1 and X_2 factors are shown in Fig. 6.

Consideration of the constructed diagrams makes it possible to draw a conclusion that the zone of optimal combination of factors is constrained by SR and HD curves at A, B, C, F, G points. In this case, the surface roughness will lie within $1.2 \mu\text{m} < SR < 1.4 \mu\text{m}$, and the degree of hardening $44\% < HD < 45\%$.

With such indicators of the optimization criteria, the value of the roller profile radius should be 16...20 mm and the speed of reeling 27...36 m/min.

Consecutively changing the combination of factors, two-dimensional sections of the response surfaces were obtained for all possible combinations of factors.

For example, by combining the values of the angle of indentation (X_3) and the number of revolutions of the rope block (X_4) at $X_1=0$ (the roller profile radius) and $X_2=0$ (speed of reeling), the following regression equations were obtained:

$$SR = 1.9224 - 0.5837 \cdot X_3 - 0.4970 \cdot X_4 + 0.359 \cdot X_3 \cdot X_4 + 1.405 \cdot X_3^2 - 1.280 \cdot X_4^2; \quad (16)$$

$$HD = 47.5008 + 0.135 \cdot X_3 + 0.1157 \cdot X_4 - 1.062 \cdot X_3 \cdot X_4 - 0.925 \cdot X_3^2 + 0.931 \cdot X_4^2. \quad (17)$$

Solution to the system of equations has produced coordinates of the centers of the response surfaces:

– for the surface roughness: $X_3=0.22$; $X_4=-0.16$; $\alpha=3.81^\circ$; $Y_5=1.89$;

– for the degree of hardening: $X_3=0.08$; $X_4=-0.01$; $\alpha=14.8^\circ$; $Y_5=47.50$.

Fig. 7 shows results obtained for equations (16) and (17) from which it is evident that the zones of the optimal combination of factors are constrained by the SR and HD curves in A, B, C and C, D, E points. In this case, surface roughness in both zones is about $1 \mu\text{m}$, the degree of hardening is 47% at the roll indentation angle of $4^\circ \dots 7^\circ$ and the number of the rope block revolutions of 265...300 rev.

Significance of the obtained estimates of coefficients and the adequacy of the model was checked using the Cochran's G-criterion and the Fisher's F-criterion.

When optimizing the technological process of reeling the rope block with a wedge roller, optimum working conditions were obtained by planning the experiment. They have appeared to be the following: the roll profile radius (X_1) 15 mm, the reeling speed (X_2) 40–50 m/min, the roll indentation angle (X_3) 5 degrees, the number of the rope block revolutions (X_4) 160–180 rev. (Fig. 6, 7).

Their optimal combination forms quality of the technological process of steel part surface hardening by reeling with rollers at

indicators of surface roughness (SR) of $1 \dots 1.9 \mu\text{m}$ and the hardening degree (HD) of 46.5...56%.

Data on wear are given in Table 2.

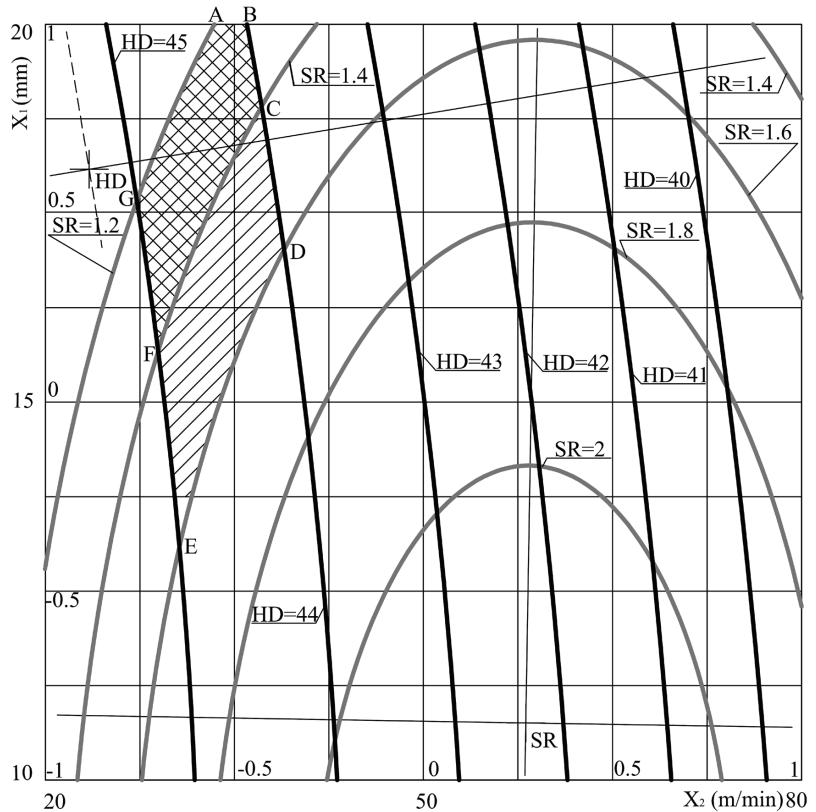

Fig. 6. Two-dimensional cross sections of the response surface after combination of the X_1 and X_2 factors at $X_3=0$ and $X_4=0$

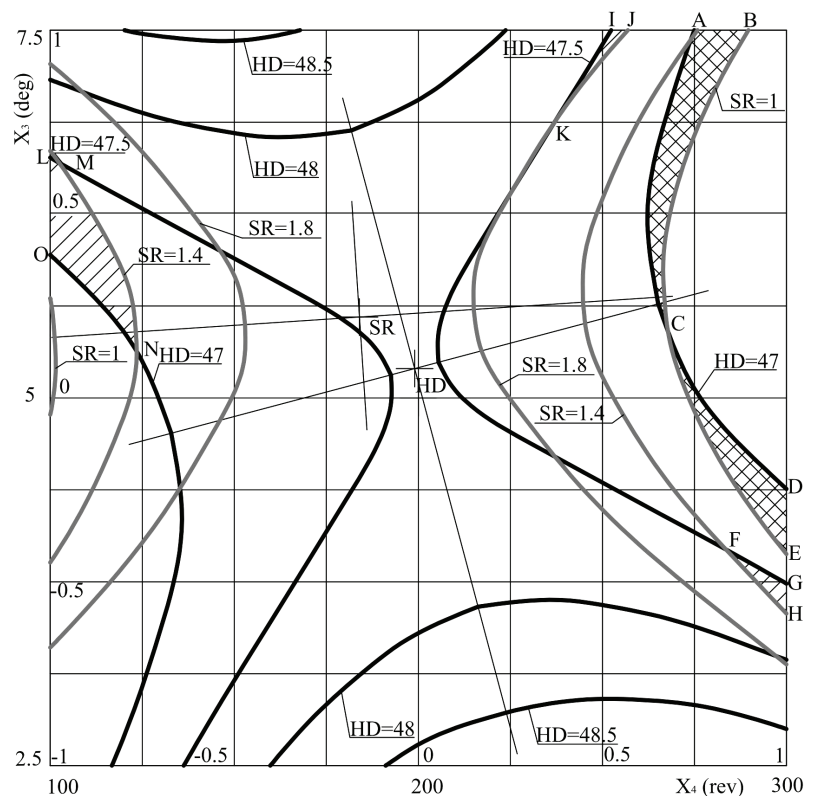

Fig. 7. Two-dimensional cross sections of the response surfaces for combining X_3 and X_4 factors at $X_1=0$; $X_2=0$

Table 2
Spalling the rope block working surface (800/120)
of the KRUPP ship reloader

Wearing part	Wear, mm	Operation period, months	Average wear, mm/month
Non-reeled block	4.3	4	1.0
	3.8	3	1.26
Reeled block	3.9	16	0.24
	3.2	12	0.26

It has been shown that reeling of the rope block working profile with rollers increases the contact strength and therefore imparts a 3 to 4 times higher durability. Accordingly, durability of ropes also improves as bending of the rope wires on irregularities of the worn rope block is eliminated.

The procedure of the rope block reeling to increase wear resistance and contact strength has been implemented on Krupp ship reloaders (Germany) in the cargo port of Mykolayiv Alumina Plant OJSC (Ukraine) and the auto cranes KS-3575 built by Mykolayivbudmechaniizatsiya JSC (Ukraine).

6. Discussion of results of tribological studies and process conditions of reeling steel parts with rolls

Yield strength of the work hardened layer increases to a greater extent than hardness (100–130 % versus 20–60 %). Due to this, boundary of the deformed layer is more clearly found by the change of the yield strength. Use of cylindrical needle rollers of small diameter in the reeling process results in a sharp increase in the degree of deformation in a thin surface layer which is recorded on optical microphotographs as grain elongation in the direction of reeling.

Accuracy of determining boundary of the work hardened layer by the method of regression analysis using the results of measuring the yield strength is two times higher than in the case of using the results of Vickers hardness tests. The 95-% confidence intervals for the depth of work hardening with toroidal and cylindrical rollers calculated on the basis of the results of measuring the yield strength make up 11–36 % of the depth of work hardening and the corresponding figures for hardness tests are 32–75 %.

Strengthening of the surface layers by reeling the shafts with a roller is mainly due to the emergence of dislocation cells in the structure of grains of excess ferrite. Ferrite plates of perlite show smaller deformation. Deformations of cementite plates during reeling with toroidal rollers were not detected.

An increase in the degree of work hardening by reeling with a needle roller manifests itself in a higher density of dislocations and the reduced cell size in the substructure of ferrite grains, as well as in a thicker grid of dislocations in ferrite plates of perlite. In some locations, bending and fracture of cementite plates occur indicating the extreme degree of plastic deformation of the surface layer. This is confirmed by the onset of peeling on the surface reeled with a 5 mm roller.

Diffusion of chemical elements of the surface layer in the process of surface deformation was studied. It was established that the content of Cr and C in the transition zone

was 20–30 % lower and 10–15 % higher in the hardened layer. Based on these studies, a hypothesis of diffusion of strengthening chemical elements (Cr, C) from the intermediate layer to the surface of the part was put forward. The main mechanism of diffusion during SFW is the dislocation density gradient.

When friction surfaces are contacting each other with a slip less than 5 %, wear does not depend on the surfaces hardness but when hardness of one of the surfaces increases, then an increased wear of the other surface should be taken into account. Roughness of the friction surfaces affects the coefficient of friction and the speed of the tribo-contact wear when reeling proceeds with a slippage, e. g. with the decrease in roughness of the surface after its reeling with rollers, the coefficient of friction decreases in presence of lubrication [18].

When slippage measures up to 2 %, a sharp change of the coefficient of friction can be observed after which it remains virtually unchanged due to the spread of slippage over the entire contact area [19].

When reeling proceeds with slippage, the main mechanisms of wear are oxidizing and fatigue (spalling) wear. Spalling deformation increases with the growth of slippage if tangential stresses are sufficiently high.

A procedure for determining conditions of reeling the rope blocks with a wedge roller was developed. In order to prevent excessive hardening and scaling of the reeled metal, a limitation to the reeling force with an average angle of indentation not more than 5° was introduced.

The method of reeling the rope blocks and other steel parts of rotation having a complex profile was developed to improve wear resistance and contact strength [14]. Advantage of the wedge roller consists in equilibrium of the axial component of the reeling force and reeling of the working profile of the rope block is possible on horizontal and vertical lathes in a single positioning.

The device and technology of the rope block reeling with a wedge roller have been developed to provide low roughness and high degree of work hardening of the surface [15]. This effect is achieved by maintaining constant the average angle φ of roller indentation into the surface to be worked and mounting the roller unit in rolling bearings. This contributes to the uniform deformation of the surface layer in absence of waviness and leads to higher wear resistance and contact strength and hence durability of the rope blocks.

A set of laboratory devices was developed to determine roughness of the reeled surface by means of replicas and the degree of work hardening of the working surface. This will assist in studying physical and mechanical properties of steel parts of a complex shape working under a contact loading, including the rope blocks. This ensures obtaining of correct indicators of the technological process of work hardening using the designed device with a wedge roller.

Tribotechnical characteristics of the reeled rope blocks were defined with the help of a device with a wedge roller: the angle of indentation and the profile radius of the wedge roller, the number of revolutions of the steel rope block and speed of reeling. This has made it possible to ascertain possible limits of variation of main design and technological conditions of strengthening with the proposed device and elucidate shape of the wedge roller.

As a result of experimental study with the use of the method of steep convergence, optimal design and kinematic parameters of the reeling process were determined. Opti-

imum working conditions were obtained by planning the experiment with optimization of the technological process of reeling the rope block with a wedge roller. They are the roller indentation angle: 5°, the roller profile radius: 15 mm, the number of the rope block revolutions: 160–180 rev., the speed of reeling: 40–50 m/min.

The optimum combination forms quality of the technological process of surface hardening of the rope blocks by reeling with rollers with the following indicators: surface roughness of 1...1.9 μm and hardening degree of 46.5...56 %.

The conducted experimental studies have proved adequacy of the results obtained in physical and mathematical modeling of the tribotechnical processes occurring during reeling the working friction surface of the rope block with a wedge roller. This allows us to recommend the developed mathematical models for their application in hardening steel parts working in conditions of wear and action of contact forces in the mechanical engineering and other industry sectors.

The reeled rope blocks were tested for spalling with ropes in operation conditions of ship reloaders of Mykolayiv Alumina Plant OJSC and freight cranes of Mykolayivbudmechanization JSC.

It has been shown that reeling of the working profile of the rope blocks ensure a 3–4 times higher durability and contact strength and therefore service life. Accordingly, service life of ropes improves as well due to elimination of the rope wire bending over the surface irregularities of the worn rope block.

The proposed hardening technology can be used for other large-sized steel parts working in wear conditions in various industries. Tribological studies of the «rope block – rope» friction couple during reeling taking into account slippage do not provide absolute correspondence with the actual course of the wear process but is a necessary step in the development of computational engineering methods for predicting wear resistance of friction units which will facilitate development of techniques to improve their service life. Further studies in this direction should be conducted by dissemination of the proposed technology to other machinery friction units and their corresponding laboratory wear test patterns.

7. Conclusions

1. With application of the regression analysis methods, the actual accuracy of determining the depth of hardening has been estimated using the data on changes in mechanical properties of the surface layer metal. It was established that accuracy of determining the boundary of the work hardened layer according to the yield strength change is twice as high as that according to the hardness change. It was shown that the depth of work hardening which is determined according

to the changes in the yield strength is 25–50 % greater than the depth determined according to the Vickers hardness change. This difference grows with the decrease in the work hardening degree.

2. Diffusion of strengthening chemical elements taking place in the surface layer during the process of surface deformation was studied. It was established that the content of Cr and C decreased by 20–30 % in the transition zone and increased to 10–15 % in the hardened layer. When reeling steel of 40X and 45 grades with rollers, a significant reduction of microhardness in the transition zone between the hardened layer and the initial metal was observed. When reeling Armco iron, this reduction cession was not detected. Based on these studies, a hypothesis of diffusion of the strengthening chemical elements Cr and C from the intermediate layer to the surface of the part due to the dislocation density gradient has been advanced.

When contacting of friction surfaces occurs with a slip of less than 5 %, wear does not depend on hardness of these surfaces. However, when hardness of one of the surfaces increases, the increased wear of the other surface should be taken into consideration. Roughness of the friction surfaces affects the coefficient of friction and wear rate when reeling with slippage. For example, when surface roughness decreases after reeling with rollers, coefficient of friction decreases in lubricated surfaces. Therefore, contact fatigue strongly depends on evenness of rotation and deformation which determines dependence on slippage, the tribosystem rigidity and shape deviation from ideal bodies of rotation.

3. A procedure for calculating the depth of work hardening for the case of reeling the part friction surface with a wedge roller was proposed and the limits of its rational application were set. An original technique of reeling steel parts was developed in order to increase their contact strength and wear resistance. This technique makes it possible to intensify the process and optimize conditions of plastic deformation, increase productivity of the reeling process, and achieve specified tribotechnical properties of the friction surfaces in large-sized steel parts.

A device and a technology of the rope block reeling with a wedge roller have been developed. Optimal design and kinematic parameters of the device (beating, eccentricity, the roller diameter and curvature, the reeled part curvature and normal strengthening between the roller and the part in the deformation zone in all points of the part profile) were substantiated. The obtained optimum values provide the specified tribotechnical characteristics, namely, smaller roughness and higher hardness of the working friction surface after reeling which improves service life of the parts and units. The conducted experimental studies have proved adequacy of the results of physical and mathematical simulation of the processes occurring during reeling of the working friction surface of the rope block.

References

1. Babei Y. I., Butakov B. I., Sysoev V. G. Surface hardening of metals. Kyiv: Scientific Opinion, 1995. 256 p.
2. Kuzmenko A. G., Lyubin A. G. Contact mechanics and calculations on the wear of sliding supports: monograph. Khmelnytsky: KhNU, 2008. 550 p.
3. Tribology / Kindrachuk M. V., Labunets V. F., Pashechko M. I., Korbut Y. V. Kyiv: NAU-druk, 2009. 392 p.
4. Stress-deformed state of composite material loaded with friction and temperature / Kindrachuk M. V., Kornienko A. O., Fedorchuk S. V., Tisov O. V. // Problems of tribology. 2006. Issue 1. P. 153–157.

5. Improving of the wear resistance of working parts agricultural machinery by the implementation of the effect of self-sharpening / Aulin V., Warouma A., Lysenko S., Kuzyk A. // *International Journal of Engineering & Technology*. 2016. Vol. 5, Issue 4. P. 126–130. doi: 10.14419/ijet.v5i4.6386
6. Kuzmenko A. G., Dicha O. V. Contact, friction and wear of oiled surfaces: monograph. Khmelnytsky: KhNU, 2007. 344 p.
7. Handbook for cranes. Vol. 1 / Braude B. I., Gohberg M. M., Zvyagin I. E. et. al.; M. M. Gohberg (Ed.) // *Characteristics of materials and loads. Basics of calculation of cranes, their drives and metal constructions*. Moscow: Mechanical Engineering, 1988. 536 p.
8. Voloshin V. I. Influence of wear of the blocks on the work of lifting ropes // *Pod'emno-transportnoe oborudovanie*. 1986. Issue 17. P. 65–66.
9. Chernets M. V. Prediction of the life of a sliding bearing based on a cumulative wear model taking into account the lobing of the shaft contour // *Journal of Friction and Wear*. 2015. Vol. 36, Issue 2. P. 163–169. doi: 10.3103/s1068366615020038
10. Soldatenkov I. A. Evolution of contact pressure during wear of the coating in a thrust sliding bearing // *Journal of Friction and Wear*. 2010. Vol. 31, Issue 2. P. 102–106. doi: 10.3103/s1068366610020029
11. Mezrin A. M. Determining local wear equation based on friction and wear testing using a pin-on-disk scheme // *Journal of Friction and Wear*. 2009. Vol. 30, Issue 4. P. 242–245. doi: 10.3103/s1068366609040035
12. Togawa K., Arai S., Uwatoko M. 104 Influence of Traction Sheave P.C.D. Difference on Sheave and Rope // *The Proceedings of the Elevator, Escalator and Amusement Rides Conference*. 2012. Vol. 2011. P. 31–34. doi: 10.1299/jsmeearc.2011.31
13. Ryu J. B., Chae Y. H., Kim S. S. A Fundamental Study of the Tribological Characteristics of Sheave Steel against a Wire Rope // *Key Engineering Materials*. 2005. P. 1382–1387. doi: 10.4028/0-87849-978-4.1382
14. Dykha A. V., Kuzmenko A. G. Solution to the problem of contact wear for a four-ball wear-testing scheme // *Journal of Friction and Wear*. 2015. Vol. 36, Issue 2. P. 138–143. doi: 10.3103/s1068366615020051
15. Determining the characteristics of viscous friction in the sliding supports using the method of pendulum / Dykha A., Aulin V., Makovkin O., Posonskiy S. // *Eastern-European Journal of Enterprise Technologies*. 2017. Vol. 3, Issue 7 (87). P. 4–10. doi: 10.15587/1729-4061.2017.99823
16. A method of finishing and strengthening the processing of surfaces of the bodies of rotation of a complex profile and a device for its implementation: Pat. No. 93252 UA. IPC V 24 V 39/04 / Butakov B. I., Shebanin V. S., Butakova G. S., Marchenko D. D.; Applicant and patent holder Mykolaiv State Agrarian University. No. a200815098; declared: 29.12.2008; published: 25.01.2011, Bul. No. 2.
17. A device for finishing and strengthening the surfaces of bodies of rotation of a complex profile: Pat. No. 2493954 RF. IPC V 39/04, B 21 N 1/22 / Butakov B. I., Shebanin V. S., Butakova G. S., Marchenko D. D.; Applicant and patent holder Nikolayev State Agrarian University. No. 2010147733/02; declared: 22.11.2010; published: 27.09.2013, Bul. No. 27.
18. Butakov B. I., Marchenko D. D. Promoting contact strength of steel by rolling // *Journal of Friction and Wear*. 2013. Vol. 34, Issue 4. P. 308–316. doi: 10.3103/s106836661304003x
19. Erdonmez C., Imrak C. Modeling and numerical analysis of the wire strand // *Journal of Naval Science and Engineering*. 2009. Vol. 5, Issue 1. P. 30–38.