

Представлені результати дослідження ресурсозберігаючої технології наплавлення двома стрічковими електродами з контрольованим перенесенням електродного металу з торців стрічкових електродів і з регульованим співвідношенням швидкостей подачі стрічкових електродів. Для реалізації запропонованої технології наплавлення розроблено пристрій, що дозволяє змінювати співвідношення швидкостей подачі першого і другого електродів в широкому діапазоні. За рахунок цього досягається контрольоване тепло- масоперенесення в зварювальну ванну. Відповідно, контрольоване оплавлення стрічкових електродів і розподіл теплової енергії в зварювальній ванні. Це дозволяє підвищити якість наплавлених виробів за допомогою простого і надійного ресурсозберігаючого пристрою.

Дана конструкція дозволяє оптимізувати параметри імпульсного механічного перенесення і запобігти деформуванню стрічкових електродів, забезпечити по чергове зворотно – поступовий рух торців стрічкових електродів з оптимальними частотою і амплітудою. Це забезпечує оптимальні розміри наплавленого валику при можливості зменшення витрат електродного металу на втрати і перегрів, відповідно, енергії, що витрачається на плавлення і забезпечити ресурсозберігаючу технологію наплавлення.

Процес наплавлення двома стрічковими електродами, навіть при використанні флюсів, рекомендованих для зварювання, частково протікає як електрошлаковий, так як певна частка струму шунтування розплавлюється шлаком. Це сприяє зниженню глибини проплавлення і зменшення частки участі основного металу в наплавленому. Дозволяє отримати наплавлений метал необхідного хімічного складу вже в 1-м або 2-м шарі, на відміну від одноелектродного наплавлення, де необхідно наносити від 3-х до 5-и шарів.

Результати досліджень впливу частоти коливань стрічкових електродів показали, що максимальне збільшення коефіцієнту розплавлення відбувається при використанні частоти коливань в інтервалі 45–55 Гц незалежно від інших параметрів режиму

Ключові слова: стрічковий електрод, ресурсозберігаюча технологія, контрольоване тепло-масо перенесення

UDC 621.791.92

DOI: 10.15587/1729-4061.2019.154681

IMPROVING A RESOURCE-SAVING SURFACING TECHNOLOGY USING TWO RIBBON ELECTRODES WITH A CONTROLLED TRANSFER OF ELECTRODE'S METAL

E. Lavrova

PhD, Associate Professor*

E-mail: lavrova.e.v.pstu.edu@gmail.com

V. Ivanov

PhD, Associate Professor*

E-mail: ivanov_v_p@pstu.edu

V. Royanov

Doctor of Technical Sciences, Professor*

I. Zakharova

PhD, Associate Professor*

V. Kibish*

E-mail: abdulovvladislav@gmail.com

*Department of Automation and

Mechanization of Welding Production

Priazovskiy State Technical University

Universytets'ka str., 7,

Mariupol, Ukraine, 87555

1. Introduction

The process of surfacing under a hard flux with two successive electrode ribbons is associated with increased heat addition to the base metal, which leads to an increase in the amount of welding and slag baths. Under certain conditions, it promotes the growth of the proportion of the base metal in the surfaced metal, thereby reducing the level of doping of the surfaced layer. Control over arc power by the surfacing mode settings exerts an impact on the steady character of surfacing process due to changes in the ratio of masses of the molten metal to slag. Thus, an increase in voltage while maintaining the magnitude of surfacing speed intensifies the fluxes of metal and slag along the front of melting that

leads to the formation of an uneven surface of the surfaced layer, even to that the surfacing bath leaks through a slag coating. In addition, there is an increase in flux consumption in the amount of molten slag, which complicates its holding. An increase in current might lead to slag leaking in front of electrode ribbons.

At surfacing by two ribbon electrodes, an important role belongs to the transfer of electrode metal from two sources, each of which has independent adjustable characteristics. It is necessary to take into consideration the conditions for melting and heat transfer for each of the electrodes; they vary depending on their location in a common welding bath. A second electrode is surrounded by a larger mass of molten slag and, in addition, beneath it is a layer of liquid metal cre-

ated by a first electrode. The relevance of work in this field is to control the formation of a welding bath while taking into consideration the impact exerted on the base metal by two independent sources of heat; in this case, the conditions for heat transfer to each base metal by each electrode are not equivalent.

2. Literature review and problem statement

At sequential position of two ribbon electrodes, at surfacing under a hard flux with a controlled transfer of an electrode's metal, a second electrode comes in contact with a liquid layer, formed by a first electrode, on one side, and an overheated slag formed in the gap between the electrodes. This affects the distribution of liquid metal flows in a welding bath, the parameters of a penetration zone, and the formation of a surfaced bead. By redistributing currents in the electrodes, it is possible to adjust the thermal and gas-dynamic impact of each arc on the molten metal in a welding bath, thereby ensuring the uniform distribution of its flow along the entire front of surfacing. [1]. In order to reduce the likelihood of defects in the form of slag inclusions, undercuts at the edges of the bead, uneven line of fusing, it is necessary to change additional technological parameters. That would make it possible to more flexibly control the formation of a welding bath and to influence service characteristics of the surfaced layer.

Paper [2] considered the possibility to increase specific power and to reduce electricity consumption during heating at electrosag heating, but it did not identify techniques to reduce the depth of fusion penetration of the base metal.

Work [3] reported a technique of multi-electrode surfacing [3], which makes it possible to improve the quality of a surfaced layer by redistributing thermal power from the center to the edges of the surfaced bead. However, the described device does not make it possible to control the composition of a surfaced joint.

Authors of [4] investigated a possibility to control the depth of fusion penetration and the portion of the base metal by changing the mode settings at MIG and TIG-welding using a wire electrode [4]. For the case of a ribbon electrode, such opportunities were not explored.

Paper [5] suggest a mathematical model of automatic control over the processes of arc surfacing using electrode wires. The research reported makes it possible to predict the movement and distribution of a heat-mass transfer from the end side of the electrode, but only when using a wire electrode, rather than ribbon.

Mechanical forced transfer of the electrode metal makes it possible to not only control quality and geometric parameters of welded joints, but also significantly reduce energy used to add heat into a welding bath. The use of controlled mechanical electrode metal transfer at surfacing under a hard flux using a ribbon electrode ensures an improved efficiency when melting an electrode metal, as well as reduces energy intensity in the process of surfacing [6].

Study into the feasibility of such a technique for surfacing when using two ribbon electrodes [7, 8] showed the prospects for this method. At the same time, the conditions for electrode metal melting and its transfer into a welding bath pool when using two or more electrodes are different from those when surfacing using a single electrode, especially at different values for ribbon feed speed. The influence of

these parameters on the transfer of an electrode metal into a welding bath is still not known.

There are studies on the effect of temperature on an increase in the likelihood of corrosion and wear in high pressure vessels. There is an issue on improving the quality of the applied corrosion- and wear-resistant coatings in industry. Economic factors will not typically make it possible to manufacture nodes from a solid highly-alloyed material. As a result, there is the need to use low-alloyed or unalloyed base materials with a high-alloyed shell. It was proposed to use electrosag welding to apply coatings upon large surfaces using ribbon electrodes. As a result, a continuously melting electrode is melted and fused to the substrate. That leads to a significant overheating of edges of ribbon electrodes [9]. Therefore, using the proposed technique for restoring working surfaces is not rational.

Paper [10] suggests a technique to control the quality and properties of an anti-corrosion layer at electrosag welding by using a device for magnetic agitation of liquid metal in a welding bath. The application of such a device involves additional consumption of electricity to operate it.

That necessitates further research into development of a resource-saving technology of surfacing by two ribbon electrodes where the introduction of an additional mechanism ensures the controlled transfer of an electrode's metal. This would improve the quality of a surfaced layer and reduce specific consumption of electrical energy per a linear meter of the surfaced bead.

3. The aim and objectives of the study

The aim of this work is to determine the impact of surfacing mode settings on the parameters for penetrating a base metal and the stability of penetration when applying a resource-saving technology for surfacing by using two ribbon electrodes.

To accomplish the aim, the following tasks have been set:

- to design a device for surfacing under a hard flux by using two ribbon electrodes with a controlled migration of electrode metal from the electrodes' side ends;
- to investigate the effect of technological factors on the properties of an anti-corrosion layer, surfaced by two electrode ribbons with a controlled mechanical transfer of the electrode metal;
- to identify a possibility to improve a melting factor for ribbon electrodes at surfacing under a hard flux with a controlled heat-mass transfer by varying the oscillation frequency of ribbon electrodes' side ends.

4. Design of a device for surfacing using two ribbon electrodes

We have designed a device for surfacing by using two ribbon electrodes with a controlled mechanical transfer, which makes it possible to change the feed speed ratio of the first and second electrodes in a wide range. The device consists of two pairs of feeding rollers 3, 3', 4, 4' (Fig. 1), arranged sequentially along the movement of a welding head. Torque between the pairs of rollers is transmitted by gears 5 and 6, whose transmission ratio defines the feed speed ratio of ribbons 1 and 2. Imposing the reciprocating movement of end sides on the uniform feed motion of electrodes is carried out

by cam 7, located between the electrodes at the output from a feeding device and periodically twisting the ribbons at angle α . When the cam rotates at angle π , a ribbon electrode due to its elasticity returns to the starting position, while its end executes the return movement from a welding bath, which facilitates the discharge of a drop into the bath. That makes it possible to enable the controlled heat-mass transfer into a welding bath and, accordingly, controlled fusion of ribbon electrodes and the distribution of thermal energy throughout a welding bath, which makes it possible to improve the quality of surfaced products by using a simple and reliable device.

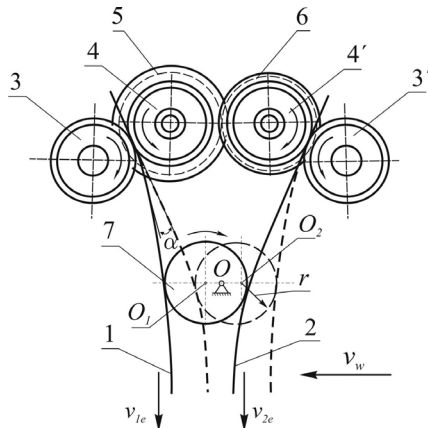

Fig. 1. Device for surfacing by using two ribbon electrodes with a controlled heat-and-mass transfer of electrode's metal: 1, 2 – ribbon electrodes; 3, 3', 4, 4' – feeding, pressing rollers; 5, 6 – gears, 7 – cam mechanism

This structure makes it possible to optimize the parameters for a pulsed mechanical transfer and prevent the deformation of ribbon electrodes, to ensure the alternating reciprocation of the ribbon electrodes' ends at optimal frequency and amplitude. That provides for the optimal size of a surfaced bead, while reducing the consumption of an electrode's metal for loss and overheating, and, respectively, the energy used for melting, thereby ensuring a resource-saving technology of surfacing.

5. Study into the influence of technological factors on the properties of an anti-corrosion layer

The surfacing was carried out on plates of steel St3 the size of 35×280×400 mm at a reverse-polarity direct current, using the 60×0.5 mm ribbons Cr25Ni22Mn4Mo2 and Cr25Ni13NbTiAl under the fluxes OF-10 and AN-26P. Surfacing mode parameters varied in the following range: surfacing current $I=900\div1,400$ A, arc voltage $U=28\div40$ V, surfacing velocity $v_w=5\div6.2\cdot10^{-3}$ m/s, gap between the electrodes is $\delta=10\div16$ mm, the ratio between feed speeds of the first and second electrode is $k=v_1/v_2=0.42\div0.79$. A gap between ribbons was due to the thickness of a copper-made current supplier. By using overlays of various thickness on the current supplier, we changed a gap magnitude over the examined interval. Change in the feed speed of ribbons was enabled by the interchangeable pairs of gears 5 and 6 (Fig. 1) with a teeth ratio within the range of factor k .

The study was conducted at the self-propelled head A-874N with an attachment for surfacing under a hard flux

using two ribbon electrodes with a controlled transfer of electrode's metal. The oscillation frequency of ribbon electrodes f changed by controlling the rotation drive of the cam mechanism. The source of welding current was the rectifier VSZh-1600. The extension of ribbon electrodes was 60 mm. During our experiments, we registered the geometric dimensions of penetration and surfacing zones, quality of forming a surfaced layer, the presence of non-welded sections, undercuts, and other formation defects (Fig. 2–4).

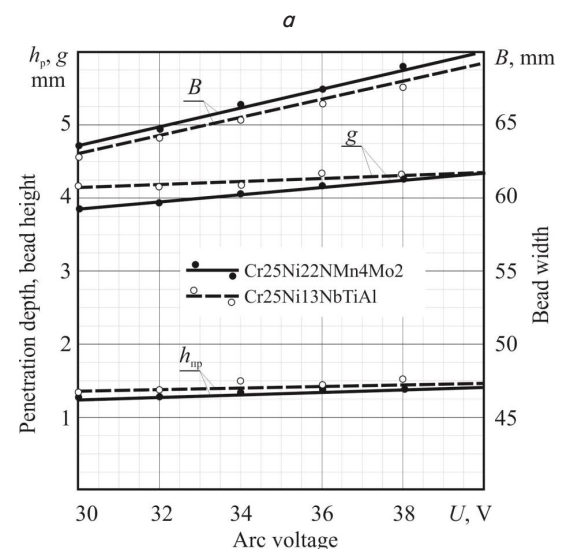
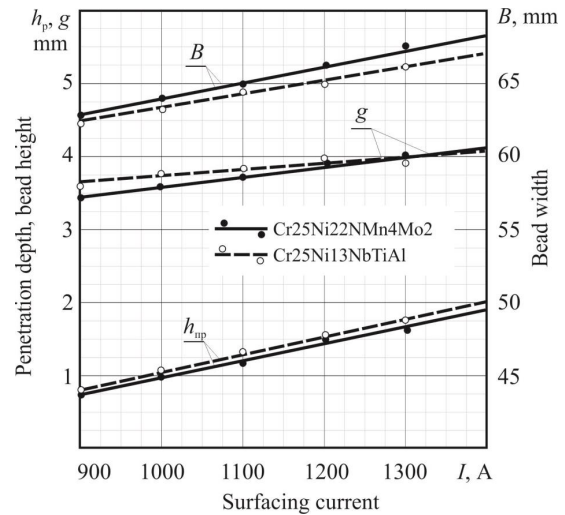

Fig. 2. Influence of surfacing current and arc voltage on the joint's geometrical dimensions: a – surfacing current I ; b – arc voltage U ; $k=0.5$; $f=35$ Hz

To determine the dependence of penetration parameters for a base metal on the feed speed ratio of ribbon electrodes, we performed surfacing using the ribbons Cr25Ni22Mn4Mo2 with a cross section of 60×0.5 mm under the flux OF-10 under the following mode parameters. Surfacing current $I=1,200$ A, arc voltage $U=32$ V, surfacing velocity $v_w=5.6\cdot10^{-3}$ m/s, a gap between the electrodes $\delta=12$ mm. The ratio of feed speeds of the first and second electrodes (at the unchanged total current magnitude) changed using interchangeable gears with values: $k=\{0.33; 0.40; 0.46; 0.5; 0.54; 0.6; 0.62; 0.66\}$. The research results are shown in Fig. 5.

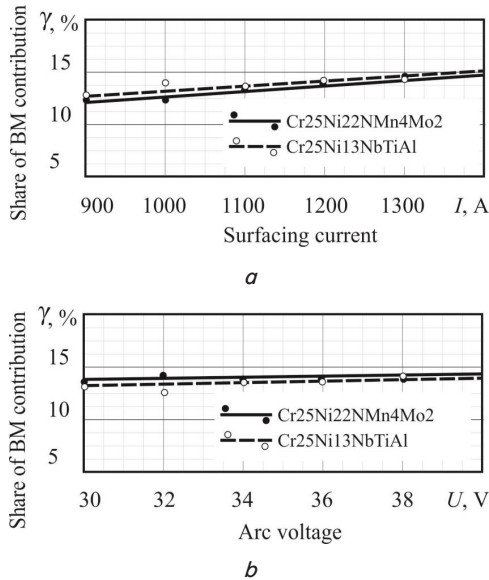

Fig. 3. Influence of surfacing current and arc voltage on the share of a base metal in the surfaced metal: *a* – current of surfacing *I*; *b* – arc voltage *U*; *k*=0.5; *f*=35 Hz

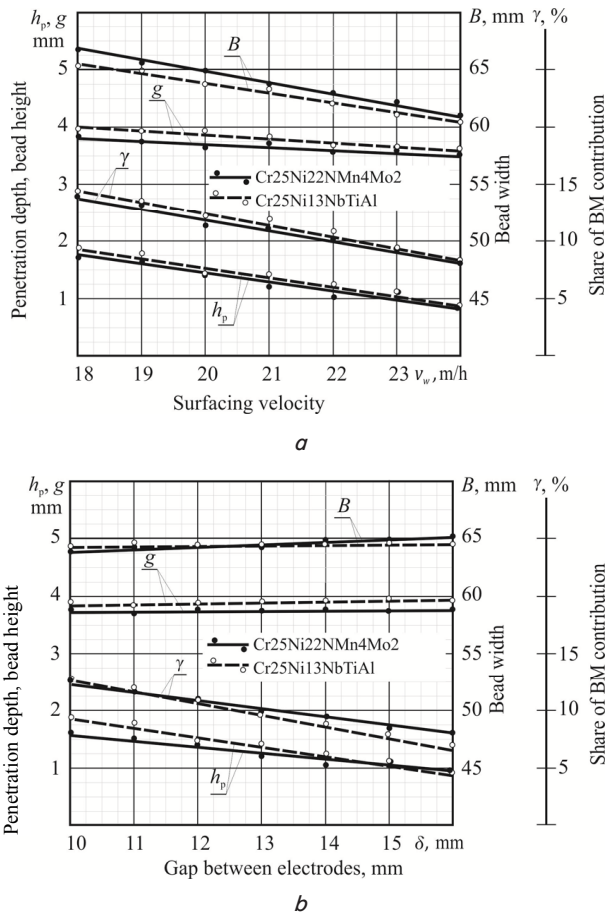

Fig. 4. Influence of basic parameters at surfacing on geometrical parameters of the welded joint: *a* – surfacing velocity *v_w*; *b* – gap between ribbons δ ; *k*=0.5; *f*=35 Hz

More control over the depth of penetration can be achieved by managing a transfer of the electrode's metal. Control is enabled by regulating the rotation frequency of the cam sandwiched between ribbons. Imposition of oscilla-

tions on the ribbons' ends, the speed of their feed, and using an additional inertia force to discharge drops into a welding bath, decreases their overheating. In this case, the magnitude of inertial force depends on several parameters. The oscillation amplitude of ribbon electrodes' ends is related to the magnitude of eccentricity and the distance between the ribbon electrodes, as well as the mass of drops of the electrode's metal, whose magnitude is determined by the cam's frequency of rotation. We have studied an oscillation frequency range of ribbons within $f=30\div70$ Hz, defined as important to control the transfer of an electrode's metal [6–8].

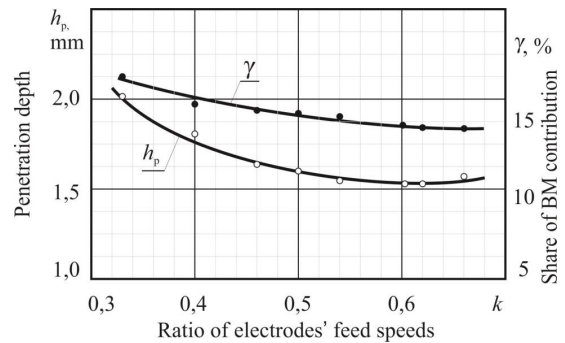

Fig. 5. Influence of electrodes' feed speed ratio coefficient *k* on the penetration parameters of base metal

Fig. 6 shows results of our study into the influence of parameters for the forced transfer on the magnitude of a melting factor at surfacing using 2 ribbons Cr25Ni22NMn4Mo2 with a cross section of 60×0.5 mm under the flux OF-10.

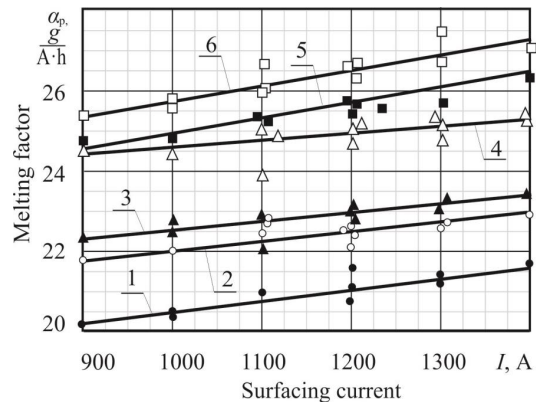

Fig. 6. Dependence of a melting factor on the surfacing mode settings: 1 – $f=0$ Hz; 2 – $f=30$ Hz; 3 – $f=40$ Hz; 4 – $f=70$ Hz; 5 – $f=60$ Hz; 6 – $f=50$ Hz

The process of surfacing when using two ribbon electrodes, even when applying the fluxes recommended for arc welding, occurs partially as the electroslog process, because a certain percentage of current is shunted by the molten slag. This helps reduce the depth of penetration and reduces the share of a base metal in the surfaced metal (Fig. 3). This makes it possible to obtain the surfaced metal with the required chemical composition as early as in the first or second layer, in contrast to the single-electrode surfacing where it is required to apply from 3 to 5 layers.

To study chemical composition of the surfaced metal, we performed a two-layer surfacing using two ribbons of the above-specified grades with a cross section of 60×0.5 mm. The mode parameters are as follows: current is 1,150–1,200 A

(direct, reverse polarity), arc voltage is 30÷32 in, surfacing velocity is $5.6 \cdot 10^{-3}$ m/s, distance between the electrodes is 12 mm. The results of a layer-wise spectral analysis of the surfaced metal are given in Table 1. It should be noted that the process of surfacing in both cases was mainly the arc process.

Chemical composition of the electrode and the surfaced metal

No.	Grade/ type	Flux	Composition of chemical elements, % by weight						
			C	Mn	Si	Cr	Ni	Other elements	
1	Cr25Ni22NMn4Mo2		0.015	4.50	0.15	25.10	22.30	2.10 Mo	0.14 N
	Layer 1	OF-10	0.035	3.60	0.60	23.00	21.30	2.00	0.12
	Layer 2	OF-10	0.025	3.89	0.60	24.61	22.30	2.10	0.12
2	Cr25Ni13NbTiAl		0.010	0.49	0.71	24.30	12.28	0.70 Nb	0.62 Al
	Layer 1	AN-26P	0.029	0.54	0.82	22.17	11.91	0.70	0.33
	Layer 2	AN-26P	0.022	0.54	0.77	23.90	12.00	0.70	0.55

An analysis of a layer-to-layer change in the content of basic alloying elements, given in Table 1, confirms the feasibility of a surfacing process using two electrode ribbons to obtain the required properties of a surfaced metal as early as in the second layer.

6. Results of studying the influence of basic parameters for surfacing mode using two ribbon electrodes on the formation of a surfaced bead

It was established that the geometric parameters of surfacing and penetration zones depend directly proportionally on the magnitude of surfacing current and arc voltage (Fig. 2). Increasing the size of a penetration zone leads to a respective change in the share of a base metal's contribution (BM) (Fig. 3), though this dependence is less pronounced. Increasing the velocity of surfacing leads to a more pronounced decrease in the depth of penetration and in the share of contribution, which can be attributed to an increase in the arc's heat used to melt the flux (Fig. 4).

This is explained by that the essential role for the penetration zone settings in most cases belongs to a first ribbon electrode. The arc of a second electrode does not directly affect a base metal, but only through a liquid layer, induced by the interaction of the arc of a first electrode, which is why increasing the arc's power of a second electrode at increase in the feed speed affects mainly the heat transfer into a welding bath and the area of a surfacing zone.

Changing the value for a feed speed ratio factor changes the influence of each of the electrodes on the formation of a penetration zone, a hydrodynamic environment in a welding bath and, respectively, the formation of a surfaced bead. Increasing the speed of the first electrode's feed leads to an increase in the depth of penetration and the share of BM contribution; at the same time, a growth of the liquid layer beneath the second electrode reduces its penetrating capacity, especially at the edges of the bath. As the center of the bath is much overheated, an increase in the depth of penetration occurs mostly along the center of the joint, in the zone of active flow of a liquid metal. That leads to the uneven formation of weld lines, with the possibility of formation of slag inclusions and flows in the regions of slow motion of the liquid metal. In this case, the height gain could be uneven along the length of a joint, contain thickenings and cavities at the surface of a surfaced bead.

An increase in the velocity ratio factor k enhances the role of a second electrode in the shape-formation of welding bath and stabilization of the liquid metal flows throughout its volume (Fig. 5). That contributes to the alignment of a fusion line, to an increase in the angle of transition from the base metal to the surfaced metal ($140 \div 150^\circ$) by increasing the width of a roller and reducing the depth of penetration, as well as promotes a better formation of the surfaced metal. The photographs, shown in Fig. 7, 8, of ribbons' ends after surfacing, as well as macrosections of fusion lines, suggest a more uniform distribution of heat in a welding bath across the width of the ribbon electrode.

A further increase in the second electrode feed speed at a decrease in the first electrode feed speed ($k \geq 0.7$) leads to a repeated growth in the penetration depth and the BM share of contribution at the expense of a decrease in the liquid layer beneath a second electrode.

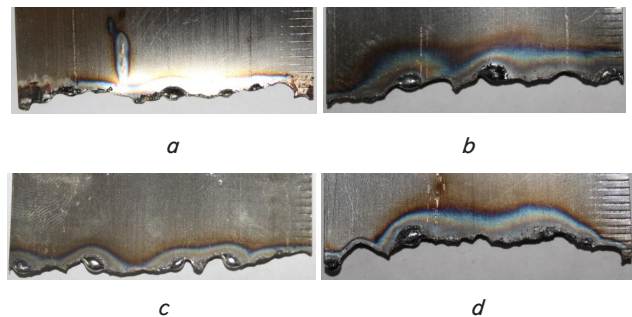

Fig. 7. Physical appearance of ribbon electrodes after surfacing at value $k=0.62$ (a, c) and $k=0.5$ (b, d): a, b – first electrode; c, d – second electrode

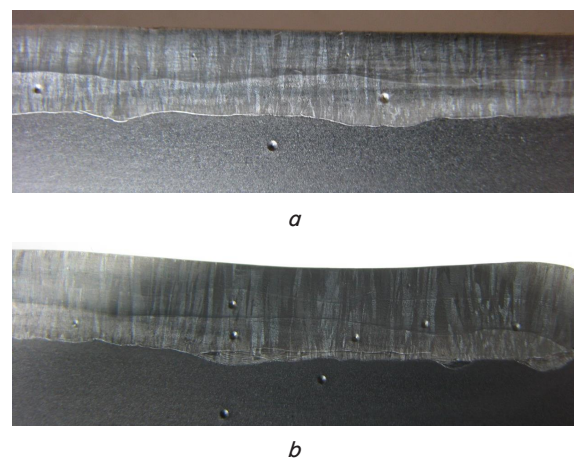

Fig. 8. Macrostructure of fusion line of the surfaced rollers, $\times 4$: a – $k=0.62$; b – $k=0.5$

7. Discussion of results of studying the surfacing using two ribbon electrodes with a controlled transfer

The device that we designed makes it possible, by changing the ratio of feed speeds of the first and second electrode, to achieve a controllable heat-mass transfer into a welding bath. This leads to the controlled melting of ribbon electrodes and distributes heat energy in a welding bath. The result is an increased quality of surfaced products owing to a simple and reliable resource-saving device.

Results of research into the influence of oscillation frequency of ribbon electrodes have demonstrated that the maximum increase in a melting factor occurs when the frequency of oscillations is in the range of 45–55 Hz, regardless of other mode settings (Fig. 9). That leads to an increase in the efficiency of melting ribbon electrodes within 20–25 %. For known surfacing techniques, such a growth would require either special technological patterns: using a filler material, fluxing additives, or an increase in the arc capacity. These techniques are energy-inefficient and costly. Therefore, application of the surfacing technique that employs two ribbon electrodes with a controlled heat-mass transfer is effective.

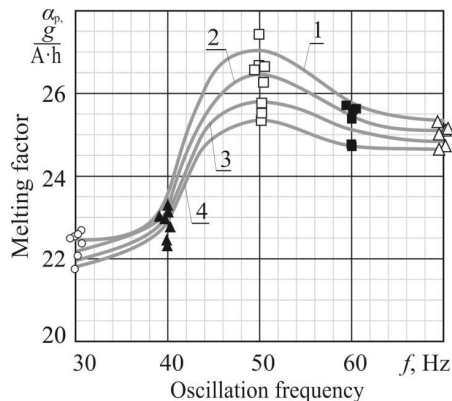

Fig. 9 Influence of oscillation frequency on melting factor:
1 – $I=1,300$ A, $U=34$ V; 2 – $I=1,200$ A, $U=32$ V;
3 – $I=1,000$ A, $U=30$ V; 4 – $I=900$ A, $U=28$ V

Thus, at mode parameters' values $I=1,300$ A, $U=24$ V, and $f=50$ Hz, a melting factor reaches values that are characteristic of the electroslag surfacing (26.7–27.5 g/A·h). This fact can be explained by a more uniform distribution of thermal energy throughout the width of a ribbon electrode and the mirror of a welding bath at an increase in its average temperature, by lower values for the overheating of drops and losses of energy to discharge drops into the crater.

It should be noted that a certain role in this process also belongs to a rather high value for the arc voltage, because at such values there is a growth in the amount of melted flux and in a slag bath volume, resulting in a corresponding increase in the shunt current. The consequence of this phenomenon is an increase in the share of the electroslag process and the intensification of heating the molten slag at a "wet" extension of electrodes.

The proposed surfacing technique using two ribbon electrodes is recommended when using ribbon electrodes

with a width from 40 mm to 100 mm and a thickness from 0.5 mm to 1.0 mm for both corrosion-resistant steels and low alloy steels.

A possible disadvantage of the proposed surfacing technique is a possibility to apply a given device only for a limited range of used thicknesses.

It is therefore appropriate to continue the study into the application of ribbon electrodes whose thickness exceeds 1.0 mm when restoring articles with large thicknesses. The specified technological challenge could be resolved by utilizing a controlled heat-mass transfer without bending a ribbon electrode. Thus, design of the device would require improvement in the future.

8. Conclusions

1. We have designed a device for surfacing by using two ribbon electrodes with a controlled mechanical transfer, which makes it possible to change the ratio of feed speeds of the first and second electrodes over a wide range. That provides for the controlled heat-mass transfer into a welding bath. And, consequently, the controlled fusion of ribbon electrodes and the distribution of thermal energy throughout a welding bath that makes it possible to improve the quality of surfaced products by using a simple and reliable resource-saving device. This design allows the optimization of parameters for a pulsed mechanical transfer and prevents the deformation of ribbon electrodes, it ensures an alternating reciprocation of ribbon electrodes' ends at optimal frequency and amplitude. This provides for the optimal size of a surfaced bead with a possibility to reduce consumption of an electrode metal for losses and overheating, as well as the energy used to melt, and to ensure a resource saving technology of surfacing.

2. The process of surfacing when using two ribbon electrodes, even when applying the fluxes recommended for arc welding, occurs partially as the electroslag process, because a certain percentage of current is shunted by the molten slag. This helps reduce the depth of penetration and reduces the share of a base metal in the surfaced metal, which makes it possible to obtain the surfaced metal with the required chemical composition as early as in the first or second layer, in contrast to the single-electrode surfacing where it is required to apply from 3 to 5 layers.

3. Results of research into the influence of oscillation frequency of ribbon electrodes have demonstrated that the maximum increase in a melting factor occurs when the frequency of oscillations is in the range of 45–55 Hz, regardless of other mode settings.

References

1. Leshchinskiy L. K., Lavrik V. P., Kasatkin O. G. Vliyanie tekhnologicheskikh faktorov na kachestvo antikorroziionnogo sloya, naplavlennogo dvumya elektrodnyimi lentami // *Avtomaticheskaya svarka*. 1986. Issue 8. P. 49–53.
2. Kuzmenko O. G. Peculiarities of heating of stamped billets in non-consumable electrode electroslag surfacing // *The Paton Welding Journal*. 2015. Vol. 2015, Issue 6. P. 34–36. doi: <https://doi.org/10.15407/tpwj2015.06.07>
3. Matvienko V. N., Mazur V. A., Leshchinsky L. K. Evaluation of shape and sizes of weld pool in surfacing using combined strip electrode // *The Paton Welding Journal*. 2015. Vol. 2015, Issue 9. P. 28–31. doi: <https://doi.org/10.15407/tpwj2015.09.04>
4. CRA Weld Overlay – Influence of welding process and parameters on dilution and corrosion resistance / Kumar V., Lee C., Verhaeghe G., Raghunathan S. Houston: Stainless Steel World America, Texas, 2010. P. 64–71.
5. Computer system for automatic control of arc surfacing processes using electrode wires / Ryabtsev I. A., Soloviov V. G., Lankin Y. N., Babinets A. A. // *The Paton Welding Journal*. 2017. Vol. 2017, Issue 6. P. 34–36. doi: <https://doi.org/10.15407/tpwj2017.06.07>

6. Ivanov V., Lavrova E. Improving the Efficiency of Strip Cladding by the Control of Electrode Metal Transfer // Applied Mechanics and Materials. 2014. Vol. 682. P. 266–269. doi: <https://doi.org/10.4028/www.scientific.net/amm.682.266>
7. Ivanov V., Lavrova E. Development of the Device for Two-Strip Cladding with Controlled Mechanical Transfer // Journal of Physics: Conference Series. 2018. Vol. 1059. P. 012020. doi: <https://doi.org/10.1088/1742-6596/1059/1/012020>
8. Ivanov V. P., Lavrova O. V. Prystryi dlia naplavlennia dvoma strichkovymy elektrodamy: Pat. No. 113454. No. u201608212; declared: 25.07.2016; published: 25.01.2017, Bul. No. 2.
9. Thakare N., Niraj S., Ram Yada V. Electro Slag Strip Cladding Process // International Journal of Modern Engineering Research (IJMER). 2014. Vol. 4, Issue 7. P. 60–64.
10. Dave S. N., Narkhede B. E. Study of the electro slag strip cladding process & effect of its parameters on welding // International Journal of Advance Engineering and Research Development. 2016. Vol. 3, Issue 12. P. 101–108. doi: <https://doi.org/10.21090/ijaerd.031220>

Наведені результати експертного дослідження артефакту історії XIV–XV століть – золотого елементу шат монгольського воїна. Отримані результати дозволяють встановити ознаки автентичності історичних пам'яток із золота даного хронологічного періоду.

Було досліджено мікроструктуру предмета при збільшенні 10–20 крат і виявлено значну ламкість та крихкість металу. При збільшенні у 150–200 крат виявлено системи тріщин з потрійними точками, окремі каверни та кавернозний характер зламу. Крім того, виявлено велику кількість дислокацій поривів та слідів течії металу на поверхні виробу, а також сліди інструментів, які використовувалися для його чищення. При збільшенні у 2000 крат виявлено вкрай складну морфологію металу з численними кавернами, а також поверхню частково розчиненого металу, яка зберігає контури древніх подряпин.

Встановлено, що більш глибокі частини сплаву частково зберегли свій хімічний склад, і вміст золота в них складає лише 62–80 %, а сплав на поверхні афінувався природним способом, й таким чином, вміст золота у ньому визначився у межах 81–98 %. Також в більш глибоких частинах сплаву концентрації срібла є підвищеними порівняно з поверхневими шарами, оскільки сполуки срібла є більш хімічно активними й виносяться з поверхні під дією зовнішніх чинників.

Визначено перелік ознак, які свідчать про автентичність предмета, й які однозначно виявляються за допомогою електронного мікроскопу, а також за результатами досліджень хімічного складу поверхні артефакту емісійним методом. Висловлено думку щодо ефективності використання електронної мікроскопії в експертній роботі для підтвердження автентичності, виявлення ознак подробиць та слідів реставрації артефактів із золотих сплавів

Ключові слова: електронна мікроскопія, мікроструктура сплаву, ознаки автентичності, історичні пам'ятки із золота

UDC 730.8-047.37:543.5

DOI: 10.15587/1729-4061.2019.157156

STUDYING THE AUTHENTICITY OF THE GOLDEN ELEMENT FROM A MONGOLIAN WARRIOR'S ARMOR BY PHYSICAL-CHEMICAL METHODS

V. Indutnyi

Doctor of Geological and Mineralogical Sciences, Associate Professor*

E-mail: indutny@nwv.com.ua

N. Merezko

Doctor of Technical Sciences, Professor, Head of Department*

E-mail: neprod2@knteu.kiev.ua

K. Pirkovich

PhD, Associate Professor*

E-mail: pirkovich@gmail.com

*Department of Commodity Science and Customs Affairs

Kyiv National University of Trade and Economics

Kyoto str., 19, Kyiv, Ukraine, 02156

1. Introduction

Most substances change their chemical composition and structure over time, as well as enter the chemical interaction with the environment. This, of course, applies to alloys of gold, which gradually recrystallize, decompose into differ-

ent phases and push out impurity elements from their own crystalline lattices [1]. Under normal atmospheric pressure and temperatures, due to climatic factors, this process takes place over the millennia. That is why the detection of attributes of its course is important as they serve the indicators for proving the authenticity of ancient history artifacts, for