

UDC 532.529.5
DOI: 10.15587/1729-4061.2019.174555

RESULTS OF EXPERIMENTAL STUDIES INTO THE DYNAMICS OF MASS-EXCHANGE PROCESSES DURING SYNTHESIS OF PROPANE HYDRATE

B. Kutnyi

PhD, Associate Professor
Department of Renewable Energy, Energy-Efficient Structures and Utility Systems
Ivano-Frankivsk National Technical University of Oil and Gas
Karpatska str., 15, Ivano-Frankivsk, Ukraine, 76019
E-mail: kytnuba1@rambler.ru

A. Pavlenko

Doctor of Technical Sciences, Professor
Department of Building Physics and Renewable Energy
Kielce University of Technology
Tysiacholittia panstva Polskoho str., 7,
Kielce, Poland, 25-314
E-mail: am.pavlenko@i.ua

Yu. Holik

PhD, Professor
Department of Heat and Gas Supply, Ventilation and Heat and Power Engineering
Poltava National Technical Yuri Kondratyuk University
Pershotravnevyi ave., 24, Poltava, Ukraine, 36011
E-mail: golik38@i.ua

Наведено схему експериментальної установки для дослідження масообмінних процесів, які відбуваються під час утворення газових гідратів. Окреслено методику виконання досліджень та застосування обладнання для проведення дослідів у дифузійному режимі, при застосуванні низькооборотних мішалок з зануреним та поверхневим розташуванням робочого колеса, швидкісної мішалки та застосування поверхнево-активних речовин. Наведено формули для визначення питомої інтенсивності масообміну на міжфазній поверхні.

Результатами натурних спостережень за інтенсивністю масообмінних процесів доведено, що динаміка масообміну між газом і водою в режимі вільної дифузії гарно апроксимується степеневою залежністю з показником $-0,8$. Визначено кількісні показники динаміки масообміну на міжфазній поверхні пропан-вода для різних термобаричних умов. Показано, як зменшується інтенсивність масообмінних процесів при входженні термобаричних умов в область гідратоутворення.

Встановлено, що застосування низькооборотних перемішувальних пристроїв (мішалок) дозволяє інтенсифікувати масообмін на міжфазній поверхні у десять і більше разів порівняно з режимом вільної дифузії. Проте, цей ефект спостерігається лише при тривалому перемішуванні. Таким чином, застосування повільних механічних мішалок з частотою обертів до 100 об/хв можна рекомендувати лише як засіб для переміщення утвореного гідрату в межах реактора.

Експериментальними дослідженнями доведено, що застосування мішалки з частотою обертів гвинта 1500 об/хв дозволяє збільшити інтенсивність масообміну в режимі гідратоутворення приблизно у 7–8 разів. Причому, максимальний ефект спостерігається саме на початку масообмінних процесів. Доведено, що застосування поверхнево-активних речовин дозволяє додатково інтенсифікувати процес гідратоутворення шляхом збільшення площі масообмінної поверхні бульбашок газу у воді.

Результати досліджень можуть застосовуватися для проектування та вдосконалення обладнання для синтезу газових гідратів

Ключові слова: газові гідрати, питомий масообмін, експериментальні дослідження, швидкість гідратоутворення, міжфазна поверхня

Received date 18.06.20019

Accepted date 19.07.2019

Published date 30.08.2019

1. Introduction

Industrial use of gas hydrates (GH) can play a large role in supplying mankind with energy. Gas hydrates are recognized as the most likely alternative fuel in many countries [1]. Their fields are prospected and developed in France, Germany, the USA, Canada, Russian Federation

and especially actively in China and Japan. In order to gain energy independence, Japan plans to start industrial production of methane from “combustible ice” near its islands in 2023 [2]. However, effective technologies for production, storing and transporting gas hydrates are still at the stage of their engineering. That is why studies in the field of synthesis of gas hydrates are relevant.

2. Literature review and problem statement

To improve GH synthesis technology, it is important to study impact of various factors on this process. It is known that the rate of hydrate formation can vary widely, virtually from two weeks to several minutes.

It was noted in [3] that it takes 100–150 hours to convert most of the water into hydrate. Moreover, under equal conditions of supercooling, formation of propane hydrate occurs about 4 times slower than that of methane. However, the authors did not consider hydrate formation accelerating means.

According to [4], kinetics of the process of methane hydrate formation is described by dependence of the following form:

$$V = V_0(1 - e^{-kt}), \quad (1)$$

where V_0 is the estimated amount of hydrate, m^3 ; k is the constant of hydrate formation rate, s^{-1} ; τ is the hydrate formation process time, s. Equation (1) does not take into account operation of dispersing devices, thermobaric conditions, presence of surfactants and a number of other factors.

Authors of [5] claimed that due to influence of the magnetic field, onset of hydrate formation can be accelerated from 10 hours to 2 hours. However, there are no data on mass exchange rate on the interphase surface in [5].

Results of experimental studies on formation of CO₂ hydrate were presented in [6]. The hydrate formation intensity was estimated based on pressure reduction in the reactor in 90 minutes. The following approximating dependence was obtained:

$$\frac{\Delta P_h}{\Delta P_0} = 1.29 \cdot \gamma^{0.85}, \quad (2)$$

where ΔP_h is the pressure drop in the hydrate suspension; ΔP_0 is the pressure drop in the hydrate suspension flow; γ is the flow rate. Formula (2) does not contain factors such as time and temperature of supercooling in the system that, as other authors have shown, significantly affect rate of hydrate formation.

It was noted in [7] that supercooling by 1–2 °C dramatically increases the rate of hydrate formation, and further supercooling gradually decreases the rate of growth of hydrate crystals. The authors did not give an equation describing hydrate formation kinetics.

Periods of gas hydrate formation in conditions of free stirring, forced stirring and application of a constant magnetic field were presented in [8]. The parameter adopted by the authors, that is, hydrate formation time, does not ensure establishment of the true speed of mass exchange processes on the interphase surface.

Authors of [9] proposed to use a water injector to accelerate hydrate formation. However, data on speed of mass exchange were not given. May be this was caused by difficulties in determining area of the interphase surface.

Equation of hydrate formation kinetics was obtained in [10] for conditions of formation of R12 (CF₂Cl₂) freon hydrate:

$$r = 0.391 \cdot \Delta t^{0.525} \phi^{0.288} \tau^{-0.452}, \quad (3)$$

where r is the rate of hydrate formation, $kg/m^3 \cdot s$; Δt is the difference in hydrate formation temperatures, °C; ϕ is the

relative amount of the hydrate-forming agent loaded into the crystallizer vessel, kg/kg . Analyzing the graphical dependences presented in this work, it becomes apparent that the rate of hydrate formation is mainly time-dependent. Influence of other factors was within the experimental error.

Influence of surfactants on the hydrate formation process was studied in [11] where experimental studies have shown that concentration of surfactants up to 0.1 % reduces propane hydrate formation temperature by 6 °C.

Results of the study of effect of salt concentration in water on the mass exchange rate during hydrate formation in a stirred chamber were given in [12]. It was established that gas absorption rate decreases with growth of water mineralization. Optimum speed of the impeller working wheel was 650–700 rpm. The authors presented the resultant empirical formula for determining the amount of methane taking part in hydrate formation, mol

$$\frac{dn}{dt}_{(p,T)} = 1.0895 \cdot A_{H_2O} \exp\left(-\frac{39.08 \cdot 10^3}{RT}\right) \times \exp(-0.628m) RT \ln\left(\frac{f}{f_p}\right), \quad (4)$$

where t is the process time, min; $R=8.314$ is the universal gas constant, $J/(mol \cdot K)$; T is the process temperature, K; A_{H_2O} is the area of interphase contact surface; m is concentration of salts in water, g/kg ; f/f_p is the parameter of deviation from equilibrium conditions. The activation energy of methane hydrate formation (-39.08 kJ/mol) used in (4) is inconsistent with the data obtained by other authors. In particular, the study [13] has demonstrated the following values: -106.204 kJ/mol for methane hydrate and -103.015 kJ/mol for ethane hydrate.

To determine hydrate formation rate, authors of [14] directed their attention on the number of moles of absorbed gas, mol:

$$\Delta n = \left(\frac{PV}{ZRT}\right)_0 - \left(\frac{PV}{ZRT}\right)_t, \quad (5)$$

where V is the volume of gas in the reactor; P , T are pressure and temperature in the reactor; Z is the gas compression ratio; t is the time from the start of the experiment. There is no relationship with the area of the interphase surface in formula (5).

Authors of [15] have proposed to determine rate of formation of gas hydrates, cm^3/min , for a bubbler used in the production of CO₂ hydrates from the following formula,

$$r = A \cdot F \exp\left(\frac{\Delta E}{RT}\right) \exp\left(-\frac{a}{\Delta T^\beta}\right) P^\gamma, \quad (6)$$

where A is the empirical constant; F is the interphase contact surface area; $\Delta E=-125.856$ is activation energy of formation of CO₂ gas hydrate, kJ/mol; a , β , γ are empirical coefficients. Formula (6) does not take into account the time of bubble floating-up in water.

Authors of [13] systematized five models of hydrate forming kinetics depending on the process conditions: on the surface of bubbles; growth of the hydrate film on a still water surface; with the use of stirrers; based on mass exchange processes and the hydrate crystal growth from ice. Empirical coefficients in equations were given only for methane and ethane.

Importance of influence of time on the hydrate formation rate was shown in [16]. The effect of dissolved gas concentration on kinetics of hydrate synthesis was considered in [17]. Analysis of these and other studies [18, 19] indicates lack of information on speed of the mass exchange processes occurring in hydrate formation. Lack of such important information significantly complicates design of industrial plants for synthesis of hydrates.

3. The aim and objectives of the study

The study objective was to quantify impact of various factors on mass exchange in hydrate formation conditions. This would enable determining of optimal ways to intensify the hydrate synthesis process.

To achieve this objective, the following tasks were set:

- consider dynamics of mass exchange between gas and water in conditions of free diffusion;
- study the effect of low-speed stirring devices (stirrers) located at different depths on intensification of mass exchange occurring on the interphase surface;
- determine quantitative indicators of intensification of mass exchange with participation of a high-speed stirrer; advantages and disadvantages of using stirrers of this type;
- find out the mechanism of surfactant effect on the mass exchange processes in hydrate formation.

4. Experimental setup and methods of study of mass exchange processes

The studies were carried out on an experimental setup schematically represented in Fig. 1. It has made it possible to control thermobaric conditions both in the hydrate formation process and beyond it. The working pressure range was 0.1–0.5 MPa, operating temperature range was 0 °C to +12 °C.

The procedure of the field studies. The reactor 2 is filled with a measured amount of water. Water may be distilled or may contain various impurities in specified amounts. After filling, the reactor is sealed with a lid, Fig. 2. To create “working” temperature and isothermal conditions, water is

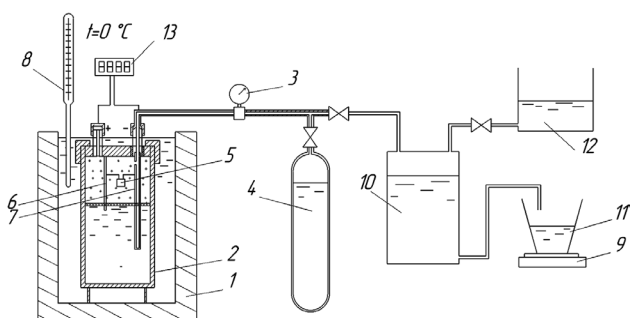

Fig. 1. The setup used in the study of mass exchange occurring in hydrate formation: 1 – thermally insulated housing ; 2 – stainless steel high pressure vessel (reactor); 3 – pressure gauge; 4 – compressed (or liquefied) gas cylinder; 5 – electronic temperature sensor; 6, 7 – electrodes; 8 – thermometer; 9 – electronic scales; 10 – vessel for displaced water; 11 – measuring glass; 12 – vessel for water refilling; 13 – electronic thermometer

poured into the gap between the housing 1 and the vessel 2 and ground ice is loaded. Stationary conditions in the setup are reached after 0.5–1.5 hours (depending on intensity of stirring of the cooling medium). In isochoric conditions, the studied gas is injected to the pressure required to obtain the target pressure. The experiment is conducted for a specified period of time in isothermal conditions. Pressure values are recorded throughout the experiment according to readings of the pressure gauge 3. The gas pressure is gradually reducing due to the mass exchange processes.

At the end of the time period, temperature in the pilot setup is risen to the ambient temperature level and the gas is released into the measuring glass with water. The internal electronic temperature sensor 5 placed in the setup measures the gas temperature. The water vessel 10 is connected to the setup to measure the gas volume. Under the gas pressure, water from this vessel is displaced into the measuring glass (11) and the glass is weighed on the electronic balance 9. The above installed water vessel 12 is used to replenish the displacing vessel with water. Absolute tightness of the experimental setup is the important study condition.

Devices. A thermometer with measurement accuracy of ±0.05 °C; a pressure gauge for 4 atm with a scale interval of 0.05 atm; an electronic thermometer with measurement accuracy of 0.1 °C; electronic scales with measurement accuracy of 0.01 g.

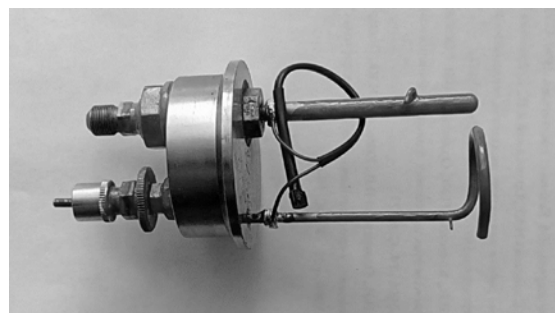

Fig. 2. Reactor lid with electronic temperature sensor installed

Since the process is isochoric, the specific mass velocity of gas diffusion, kg/(m²·s), can be determined from formula:

$$I = \frac{\Delta m_g}{F \Delta \tau} = \frac{V_{gb} \mu}{FR \Delta \tau} \left[\frac{P_1}{Z_1 T_1} - \frac{P_2}{Z_2 T_2} \right], \quad (7)$$

where V_{gb} is the gas volume in the reactor, m³; F is the area of the mass exchange surface, m²; μ is the molecular weight of the gas, kg/mol; P_1, P_2 are initial and final pressures, Pa; Z_1, Z_2 are the gas compression ratios at corresponding temperatures; T_1, T_2 are the start and end temperatures, K; R is universal gas constant; $\Delta \tau$ is the time interval, min.

Experiments of the first series were conducted to establish base values of the mass exchange rate outside the hydrate formation zone.

Experiments of the next series were carried out in thermobaric conditions characteristic of hydrate formation. The experiment procedure was as follows. The set was charged with gas at 10–11 °C. Following temperature stabilization and measurement of initial pressure, temperature of water in the reactor “jacket” was decreased to the setpoint (0–+2.5 °C) and maintained for a long time (up to 7 days). Temperature and pressure inside the reactor were measured over the en-

tire time period. As in [20], the hydrate formation process was taking place at a fixed phase boundary.

5. Experimental study of hydrate formation with the use of mechanical stirrers

Mechanical destruction of hydrate film is a common means of intensification of the hydrate formation processes [21]. Use of a variety of mechanical stirrers is the simplest option for such intensification. To study the processes of intensification of mass exchange and hydrate formation, the existing experimental setup was supplemented with a mechanical stirrer. Types of stirrers can be divided into two: "slow" and "high-speed" stirrers. Speed of the "slow" stirrer is in the range of 10–500 rpm. Speed of 500–2,000 rpm is characteristic of the "high-speed" stirrers.

The "slow" stirrer is assembled on the basis of a motor with a gearbox (Fig. 3, *a*). The motor is powered from a 2–6 V DC through a power supply unit with a voltage stabilizer. The motor has rated power of 1.5 W.

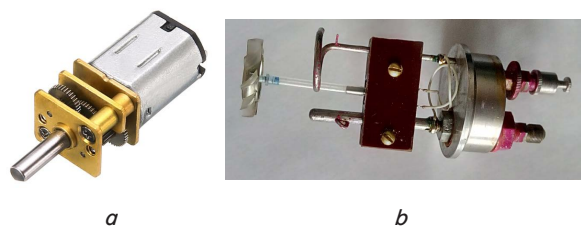

Fig. 3. Design of the "slow" stirrer: *a* – a motor with a gearbox; *b* – a working element of the submerged stirring set

As in many mass exchange devices of this type, a multi-blade impeller of the stirrer was installed beneath the water surface, Fig. 3, *b*. General diagram of the experimental setup is shown in Fig. 4.

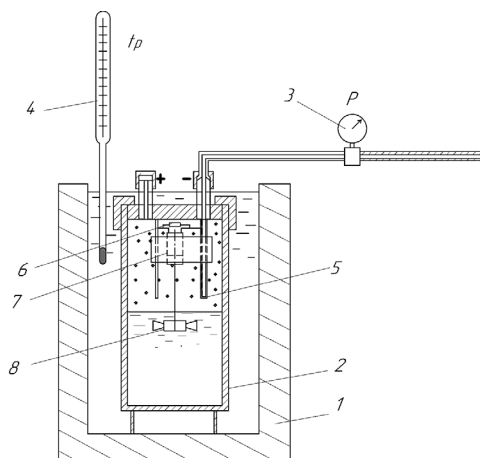

Fig. 4. The setup used for studying hydrate formation with the use of a "slow" submerged stirrer: 1 – a thermally insulated housing; 2 – a stainless steel reactor; 3 – a pressure gauge for 4 atm; 4 – a thermometer with scale interval of 0.1 °C; 5 – a tubular electrode; 6 – a gas temperature sensor; 7 – a micromotor with a gearbox; 8 – an impeller of the stirrer

The use of a surface stirrer offers several advantages: permanent destruction of the hydrate film on the interphase surface, active stirring of the fluid layers, acceleration of gas

diffusion into the liquid. To this end, impeller of the stirrer must be positioned at the level of water surface. To do this, the main shaft was shortened so that the middle of the impeller blades was exactly at the level of the water surface.

The set features stirring of the liquid surface layers with an impeller having bent blades. To change the speed of rotation, the motor voltage was varied within 1.4–5.9 V. Maximum power of the motor did not exceed 0.3 W. The impeller speed was in the range of 13–80 rpm.

In order to further intensify the mass exchange process based on the commutator micromotor, a high-speed stirrer was installed in the setup with impeller rotation speed of 1,500 rpm. At such speeds, a vortex is formed on the water surface into which gas is drawn. This gas is crushed by the stirrer blades into discrete bubbles which first are lowered with the water flow to the reactor bottom and then raised to the surface near its walls.

General view of the stirrer used in the study is shown in Fig. 5, *a*. Fig. 5, *b* shows the flow structure and bubbles formed during operation of such stirrer. The photographic measurement method has shown that about 70 % of the bubbles had relatively large dimensions: 1–3 mm in diameter. Larger bubbles deviated from the spherical shape but their number did not exceed 20 %. Not more than 10 % of bubbles had size less than 1 mm.

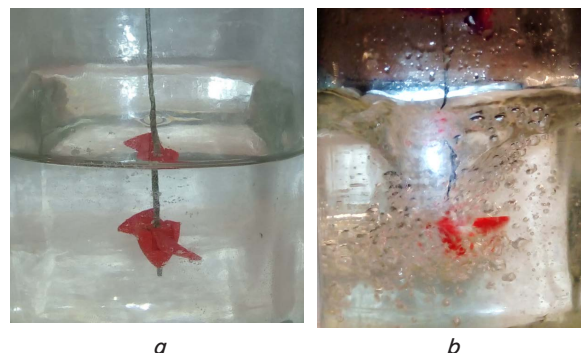

Fig. 5. A high-speed stirrer: *a* – the impeller design; *b* – vortex formed during the stirrer operation

Thus, the main advantage of the high-speed stirrer consists in a sharp increase in the effective surface area of the heat- and mass exchange surface due to formation of a large number of gas bubbles of various sizes. The extra heat inputs from the electric motor heat gas in the reactor during operation. To reduce influence of the latter factor, the high-speed stirrer was switched on during experiments only briefly, for 10 to 20 seconds.

6. The results obtained in experimental studies of mass exchange on the interphase surface

6.1. The study of mass exchange in a diffusion mode

The study was started from diffusion processes on a still interphase surface. The results obtained in processing of experimental data for propane and liquid temperatures of +8.5 °C are shown in Fig. 6. Specific mass velocity of gas diffusion into water in the reactor, kg/(m²·s) is shown on the vertical axis. Time in minutes is shown on the horizontal axis. The experimental data can be approximated by linear dependence in logarithmic coordinates. The approximation results in kg/(m²·s) give the following formula:

$$I_d = 6,12 \cdot 10^{-5} \tau^{-0.785},$$

where τ is time, min.

Similar experiments were performed for other temperatures. Specific velocity of diffusion mass exchange at a temperature of +9.5 °C is approximated by this dependence:

$$I_d = 1,02 \cdot 10^{-4} \tau^{-0.833}. \tag{9}$$

Specific velocity of diffusion mass exchange at +4.5 °C is approximated by the dependence

$$I_d = 1,10 \cdot 10^{-4} \tau^{-1.07}. \tag{10}$$

As a result of processing the experimental data in the temperature range of +9.5÷+3.7 °C and absolute pressure of 4.5 bar, approximate formulas were derived for different mass exchange conditions. The average value of specific mass exchange in kg/(m²·s) is determined by this approximate dependence:

$$I_d = 9,06 \cdot 10^{-5} \tau^{-0.806}. \tag{11}$$

When analyzing the results, we observed a significant slowdown of the specific velocity of mass exchange over time. The effect of temperature on intensity of the mass exchange processes is negligible.

Thus, we obtained a “reference” dependence of mass exchange on time. It can be compared with other variants of mass exchange processes.

Fig. 7 shows the results of processing experimental studies of intensity of mass exchange of propane with a still surface of water at absolute pressure of 4.55 bar and average temperature of +1.3 °C. Results of approximation of specific mass exchange in the zone of hydrate formation, kg/(m²·s)

$$I_g = 77,3 \tau^{-3.76}. \tag{12}$$

The following experiment was carried out on a setup with temperature stabilized at a level of +1.6 °C. Average propane pressure was 4.58 bar. Approximation of mass exchange intensity in kg/(m²·s) in the hydrate formation zone is described by this formula:

$$I_g = 0,166 \tau^{-2.59}. \tag{13}$$

Fig. 8 shows average dependences for a specific mass exchange at different thermobaric conditions. The results of approximation of several series of experimental data of mass exchange in kg/(m²·s) in the zone of hydrate formation are described by this formula (approximation reliability $R^2=0.97$):

$$I_g = 17,8 \tau^{-3.50}. \tag{14}$$

The obtained results show that active hydrate formation of propane occurs after reaching the temperature of supercooling of 2.5 °C. Mass exchange processes at the initial stage of hydrate formation occur approximately 15 times more intensively than the diffusion processes. Mass exchange processes slow down considerably after 3 hours and reach the level of diffusion. Then, intense

(8) slowdown of mass exchange continues despite the fact that there is overcooling and a sufficient excess pressure [22]. Obviously, as in [23], the film of the formed hydrate sharply slows down the process of subsequent hydrate formation.

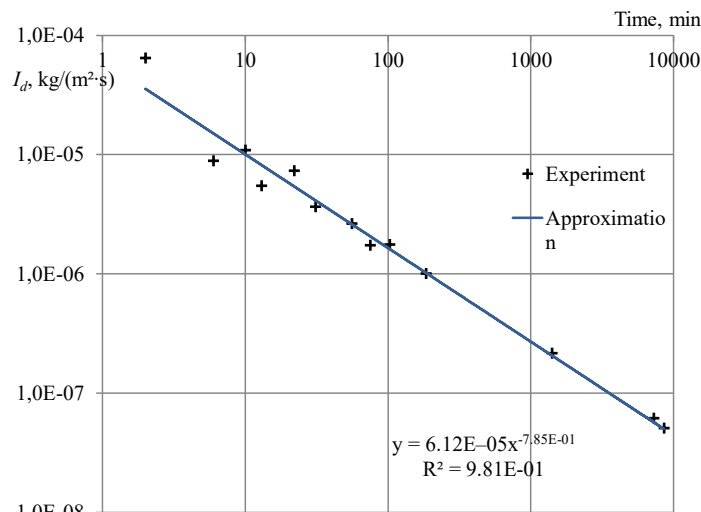

Fig. 6. Propane diffusion through the water surface at +8.5 °C

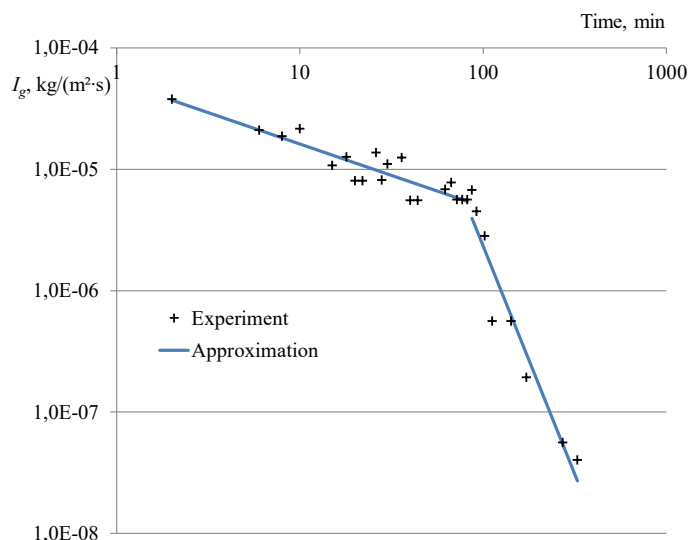

Fig. 7. Experimental data and approximation of specific mass exchange in conditions of hydrate formation

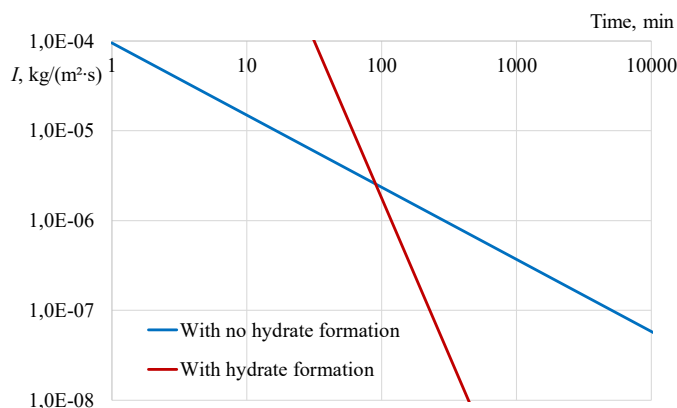

Fig. 8. Comparison of specific mass exchange with and without hydrate formation

Thus, a sharp decrease in intensity of mass exchange processes is observed in thermobaric conditions of hydrate formation. On the other hand, the lines of mass exchange in hydrate formation conditions indicate a possibility of very intense mass exchange at the initial time moments. This is confirmed by separate “unsuccessful” experiments in which the reactor was depressurized at an excess gas pressure and outside temperature was close to 0 °C. Due to the «plop», hydrate is formed almost instantly in a form of a cloud of snowflakes in the air.

6. 2. The results obtained in experiments with a “slow” stirrer

Experiments of the first series were carried out with the stirrer impeller installed under the water surface. Such arrangement of the impeller must intensify the mass exchange processes due to the forced circulation of water near the interphase surface. It was also expected that water flow near the phase interface could result in destruction of the hydrate film. The results of the study of operation of the submerged slow stirrer are shown in Fig. 9. Approximation dependences of specific intensity of mass exchange are as follows:

– outside the zone of hydrate formation, kg/(m²·s)

$$I_d = 3,08 \cdot 10^{-5} \tau^{-0.282}, \quad (15)$$

– within the zone of hydrate formation, kg/(m²·s)

$$I_g = 10,7 \tau^{-3.36}. \quad (16)$$

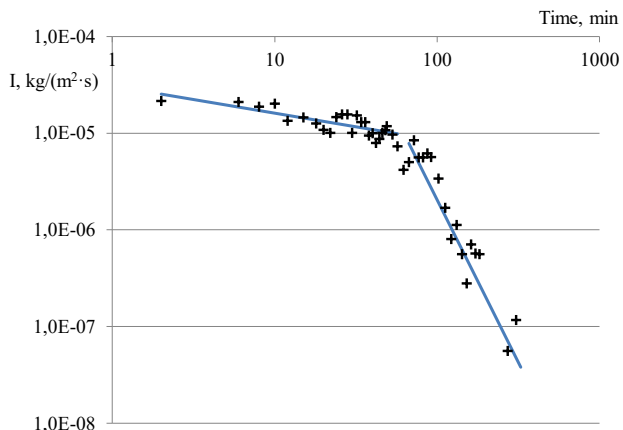

Fig. 9. Dynamics of mass exchange for the “slow” stirrer with the impeller located under the water surface

In the following experiment, the stirrer impeller was located on the water surface. The stirrer motor voltage was 1.5 V, rotation speed was 14.5 rpm, specific heat input to the gas phase was 0.15 W/l. Based on statistical processing of the experimental data, the following approximate dependences were obtained:

– outside the zone of hydrate formation

$$I_d = 9,84 \cdot 10^{-5} \tau^{-0.485}, \quad (17)$$

– within the zone of hydrate formation

$$I_g = 0,0107 \tau^{-1.62}. \quad (18)$$

Experiments were also carried out for voltage on the stirrer electric motor of 2.8 V which corresponds to the number of revolutions of the stirrer impeller: 34 rpm and specific heat flow of 0.53 W/l. The third experiment was performed at voltage of 4.9 V which corresponds to a speed of 65.5 rpm and a heat input of 1.61 W/l.

Comparison of intensity of mass exchange processes outside the thermobaric conditions of hydrate formation at operation of submerged and surface slow stirrer at different rotational speeds is shown in Fig. 10.

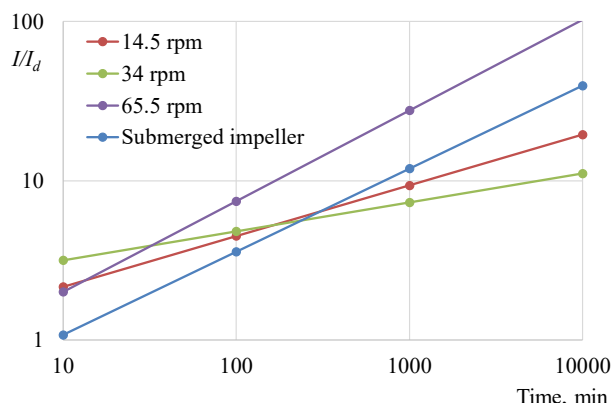

Fig. 10. Relative intensity of mass exchange outside the hydrate formation zone

At the start, effect of the submerged stirrer is almost imperceptible but mass exchange increases with time and begins to exceed 10 times the mass exchange at the still phase interface after 16 hours. Since it is too long time for industrial processes of hydrate synthesis, let us move to more intensive mass exchange processes.

Moving the impeller to the phase interface immediately results in a 2÷3 times higher intensification of mass exchange between gas and water. Influence of the stirrer with not the highest rotation speed (34 rpm) was the most effective. However, maximum intensity of mass exchange was observed at a long-term stirring and maximum revolutions (65.5 rpm). For example, the mass exchange rate at the surface stirrer operation during 2 hours was twice the mass exchange rate when using a submerged stirrer and this indicator was tenfold compared to the free diffusion conditions.

Let us consider the effect of mechanical stirring on intensity of mass exchange in thermobaric conditions of hydrate formation. Fig. 1 shows comparison of intensity of the mass exchange processes in operation of submerged and surface stirrers with the conditions of free diffusion. It is obvious that the use of surface stirrers is more than 10 times more effective than that of submerged ones. Due to the high intensity of mass exchange at the beginning of the process of hydrate formation, stirring gives slightly worse results than free diffusion. This is explained by the influence of heat from the stirrer motor. However, after 3 hours of operation of the surface stirrer, mass exchange begins to surpass the free diffusion mode. For a stirrer with a submerged impeller, this effect occurs only after 8 hours.

The fact that the stirrer efficiency decreases with an increase in its rotation speed indicates the influence of heat inputs from the motor. Their values shall not exceed 0.15 W/l. These values can only be achieved by using a

magnetic clutch to transfer torque from the motor to the impeller.

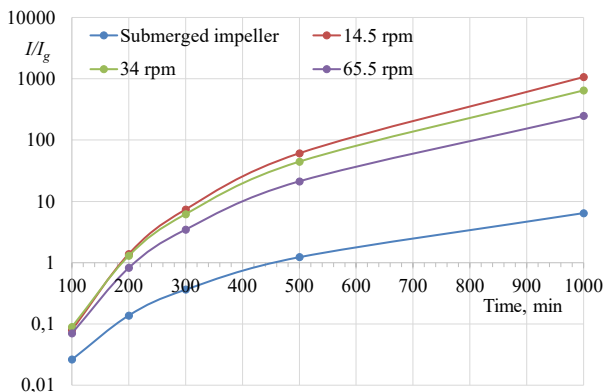

Fig. 1. The relative intensity of mass exchange within the zone of hydrate formation

Thus, the studies performed show that the use of slow stirrers can increase intensity of the processes of hydrate synthesis but the positive effect is achieved only after long stirring.

6. 3. Study of operation of the “high-speed” stirrer

Operation of a high-speed stirrer is characterized by a sharp increase in the effective area of heat and mass exchange surface due to formation of a large number of 1÷3 mm gas bubbles. The experiment was conducted with operation of a refrigeration setup with a thermostat. Water and gas temperatures were stabilized at the predetermined level within 0÷+2 °C. Propane and distilled water were taken as components of the test mixture. The measurement results have shown that volumetric heat inputs reached 10.1 W/l during operation of the stirrer motor. As a result, temperature of the gas in the reactor grew by 0.6÷1.4 °C. Therefore, the high-speed stirrer was switched on only briefly, for 12÷20 s, during the experiments.

Analysis of the measurement results (Fig. 2) shows a significant increase in mass exchange. The following is approximation formula for determining the increase in mass exchange outside the hydrate formation zone compared to the free diffusion mode ($R^2=0.88$):

$$\frac{I}{I_d} = 1 + 24.3e^{-3.18\tau}, \tag{19}$$

where τ is time, hr. The experimental data show a 12–13 times higher activation of mass exchange and the approximation dependence predicts the possibility of a 25 times higher activation. However, the use of a high-speed stirrer becomes ineffective after 40 minutes from the start of mass exchange.

Comparison of intensity of mass exchange during operation of the high-speed stirrer with the mode of free diffusion, Fig. 3, shows a significant activation at the beginning of the hydrate formation process (up to 7 times in the experimental data and up to 15 times according to the approximation forecast). Efficiency of the high-speed stirrer decreases with time and becomes ineffective after 2 hours of operation.

Approximation formula for determining the relative intensification of mass exchange in conditions of hydrate formation ($R_2=0.89$):

$$\frac{I}{I_g} = 1 + 14.7e^{-1.53\tau}, \tag{20}$$

where τ is time, hr.

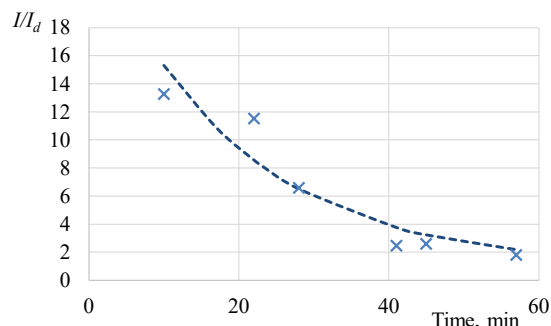

Fig. 2. The relative intensity of mass exchange within the zone of hydrate formation

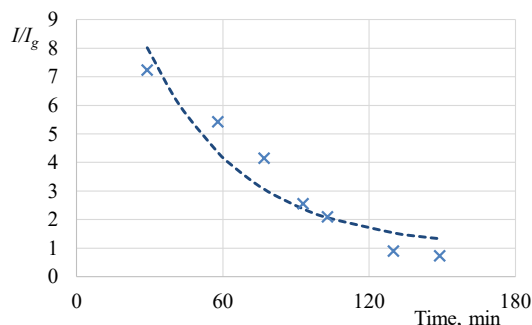

Fig. 3. Intensification of mass exchange between propane and water in the hydrate formation zone compared to free diffusion

Thus, operation of the high-speed stirrer is able to activate mass exchange by 7–8 times at the start of the hydrate formation process which can have a positive impact on the technology of synthesis of gas hydrates. Obviously, gas bubbles are the main means of intensifying mass exchange [24].

6. 4. Influence of surfactants on intensification of mass exchange

Using different types of surfactants, it is possible to significantly change surface tension on the gas bubble surface. It was experimentally found that the best results are observed with the use of a mixture of surfactants which consists of 1/3 of nonionic surfactants and 2/3 of anionic surfactants. This mixture features formation of stable foam in water, even at temperatures close to 0 °C.

The use of surfactants during operation of the slow stirrers did not show a significant difference in intensity of mass exchange processes. In the case of high-speed stirrers, maximum intensification of mass exchange with application of surfactants was less than 2–2.5 times than that for distilled water, Fig. 4, a. However, it was found that when using a surfactant, duration of the period of intensification of the high-speed stirrer was 3 times greater than that for distilled water, Fig. 4, b.

Thus, the study results indicate that growth of life time of small gas bubbles in water is the main mechanism of activation of mass exchange in the use of surfactants.

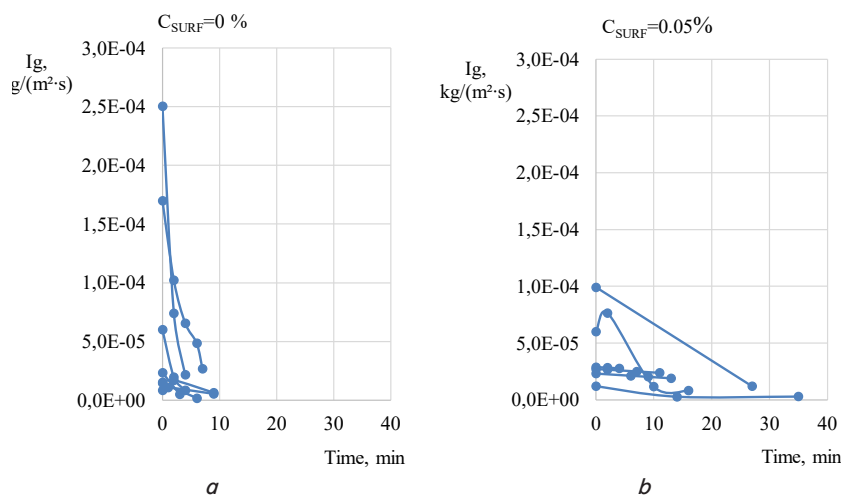

Fig. 4. Dynamics of mass exchange in the reactor immediately after switching off the high-speed stirrer at various concentrations of surfactants (each line corresponds to an individual experiment): *a* – distilled water; *b* – distilled water with a surfactant

7. Discussion of the results obtained in the studies of intensity of mass exchange processes

Results of the experimental studies show a sharp slow-down of mass exchange processes on the gas-water interphase surface in conditions of free diffusion when thermobaric conditions enter the gas hydrate zone. As a result, index of the degree of approximation dependence varies from -0.8 to -3.5 . On the other hand, dynamics of mass exchange indicates the possibility of a tenfold increase in the rate of hydrate formation process at the initial moments of time.

To intensify the technology of hydrate synthesis, the use of low-speed stirrers with the impeller installed under the water surface was considered. Compared to free diffusion, the use of slow mechanical stirrers gives a tenfold acceleration of mass exchange processes at the phase interface. However, this effect is only evident with long-term stirring (more than 12 hours). Because of the heat flow from the motor, specific mass exchange intensity is even lower in the first 8 hours than that of the free diffusion mode.

Placement of the stirrer impeller on the phase interface makes it possible to intensify the mass exchange processes 2–3 times compared to the submerged placement. However, mass exchange is still significantly slowed down in the zone of hydrate formation and an increase in the motor voltage results in an increase in heat inputs and gas heating inside the reactor.

Thus, the use of slow mechanical stirrers is possible. However, to eliminate influence of heat from the motor, it is necessary to use a magnetic clutch to transfer driving force to the impeller. This will complicate the unit structure and increase its cost. Also, an essential problem with slow stirrers consists in a small surface area of mass exchange. Therefore, their advantages over free diffusion are revealed only in long-term stirring of the liquid (more than 3 hours).

Compared to conditions of free diffusion, the use of a high-speed stirrer makes it possible to increase mass exchange rate by about 7–8 times, however this effect is observed only during the first two hours. The study results show that the effect of intensification of mass exchange is achieved by increasing area of the interphase surface with formation of a large number of gas bubbles. Measurements show that intensity of mass exchange is reduced by about

5 times within 5 minutes after switching off the high-speed stirrer. This is caused by the decrease in the number of bubbles after the stirrer is switched off. One way to avoid this phenomenon is to add surfactants to water.

The results obtained in the study of use of surfactants for high-speed dispersers show their double effect:

1. The increase in concentration of surfactants on the interphase surface reduces specific intensity of mass exchange by 2–2.5 times.

2. A three times longer period of intensification of the mass exchange processes.

Better results are obtained by applying surfactants to high-speed stirrers but these dispersants also do not allow the surfactants to demonstrate their full potential in activation of mass exchange. This is caused by small quantity (not more than 10 %) of smaller than 1 mm dia. gas bubbles.

8. Conclusions

1. It was proved that dynamics of mass exchange between gas and water in a free diffusion mode is well approximated by power dependence. Quantitative dependences of dynamics of change of mass exchange intensity on the propane-water interphase surface for thermobaric conditions both near the hydrate formation zone and within this zone were determined. It has been experimentally found that variation of temperature within $+4$ – $+10$ °C had no a significant effect on the mass exchange rate.

2. It was established that the use of slow stirring devices makes it possible to intensify mass exchange on the interphase surface ten or more times in comparison with the mode of free diffusion. However, this effect is only observed in a long-term stirring. Thus, the use of mechanical slow stirrers is only possible as a means of moving the formed hydrate within the reactor.

3. Experimental studies have shown that the use of a stirrer with impeller speed of 1,500 rpm can increase intensity of mass exchange by about 7–8 times. This is achieved by increasing area of the mass exchange surface by formation of a large number of gas bubbles having size of 1–3 mm. Disadvantage consists in the small quantity of bubbles smaller than 1 mm. To avoid additional heat inputs in the reactor working zone, it is necessary to move the motor out of this zone which may complicate the disperser design.

4. It was established that the effect of surfactants on mass exchange in conditions of hydrate formation has a double action. On the one hand, arrangement of surfactant molecules on the interphase surface reduces specific intensity of mass exchange between gas and water. However, on the other hand, surfactants make it possible to increase the mass exchange surface area due to the growth of life time of gas bubbles in water.

Practical relevance of the study consists in that its results can be used to design and improve equipment for industrial synthesis of gas hydrates.

References

1. Koh, C. A., Sum, A. K., Sloan, E. D. (2012). State of the art: Natural gas hydrates as a natural resource. *Journal of Natural Gas Science and Engineering*, 8, 132–138. doi: <https://doi.org/10.1016/j.jngse.2012.01.005>
2. Japan's Energy Supply Situation and Basic Policy. FEPC: The Federation of Electric Power Companies of Japan. Available at: http://www.fepc.or.jp/english/energy_electricity/supply_situation/index.html
3. Vorobiev, A. E., Bolatova, A. B., Baigalasova, I. L. (2012). Methodology for experimental studies of aquatic gas hydrates. *Vestnik Rossiyskogo universiteta družby narodov. Seriya: Inzhenernye issledovaniya*, 3, 24–34.
4. Bondarenko, V., Svietskina, O., Sai, K. (2017). Study of the formation mechanism of gas hydrates of methane in the presence of surface-active substances. *Eastern-European Journal of Enterprise Technologies*, 5 (6 (89)), 48–55. doi: <https://doi.org/10.15587/1729-4061.2017.112313>
5. Bondarenko, V. I., Maksymova, E. O., Ovchynnykov, M. P. (2015). Pro tekhnolohiyu vyrobnytstva shtuchnykh hazovykh hidrativ. *Ugol' Ukrainy*, 12, 33–37.
6. Rao, Y., Wang, Z., Wang, S., Yang, M. (2018). Investigation on Gas Hydrate Slurry Pressure Drop Properties in a Spiral Flow Loop. *Energies*, 11 (6), 1384. doi: <https://doi.org/10.3390/en11061384>
7. Ovchynnikov, M. P., Ganushevych, K. A., Sai K. S. (2014). The mine methane utilization from degassing wells and its transportation in a solid state. *Heotekhnichna mekhanika*, 115, 131–140.
8. Bondarenko, V. I., Sai, K. S., Hanushevych, K. A., Ovchynnikov, M. P. (2015). Rozrobka matematychnoi modeli intensyfikatsii protsesu hidratoutvorennia za rezultaty eksperymentalnykh doslidzhen. *Rozrobka rodovyshch*, 9, 259–256.
9. Pedchenko, M. M., Pedchenko, N. M. (2016). Substantiation of perspectives of use of liquid-gaseous ejector with the extended cell of mixing as reactor of the formation of gas hydrates. *Naftohazova inzheneriya*, 1, 227–235.
10. Klymenko, V. V., Lychuk, M. V., Bosiy, M. V. (2013). Application of brandon for empiricale equations kinetics of hydrate formation process. *Kholodylna tekhnika ta tekhnolohiya*, 5 (145), 59–63.
11. Dmytrenko, V. (2017). The influence surfactant and their mixture with electrolytes on gas hydrate formation. *Naftohazova inzheneriya*, 2, 89–92.
12. Nefedov, P. A., Dzhedzherova, A. A., Istomin, V. A., Dolgaev, S. I., Kvon, V. G. (2014). Osobennosti kinetiki gidratoobrazovaniya metana v vodnykh rastvorah elektrolitov. *Vesti gazovoy nauki*, 2 (18), 83–89. Available at: <https://cyberleninka.ru/article/n/osobennosti-kinetiki-gidratoobrazovaniya-metana-v-vodnykh-rastvorah-elektrolitov>
13. Zaporozhets, E. P., Shostak, N. A. (2014). Theoretical aspects of the kinetics of gas hydrates. *Zapiski Gornogo instituta*, 210, 11–20.
14. Podenko, L. S., Drachuk, A. O., Molokitina, N. S., Nesterov, A. N. (2017). Natural gas hydrates formation in dispersed ice stabilized with silica nanoparticles. *Kriosfera Zemli*, 21 (2), 43–51. doi: [https://doi.org/10.21782/kz1560-7496-2017-2\(43-51\)](https://doi.org/10.21782/kz1560-7496-2017-2(43-51))
15. Skrypnik, A., Klymenko, V. (2011). Gas hydrates technology of recycling carbon dioxide from the carbonator sugar production gas of sugar manufacture. *Tekhnika v silskohospodarskomu vyrobnytstvi, haluzeve mashynobuduvannia, avtomatyziatsiya*, 24 (1), 257–264.
16. Vlasov, V. A. (2013). Formation and dissociation of gas hydrate in terms of chemical kinetics. *Reaction Kinetics, Mechanisms and Catalysis*, 110 (1), 5–13. doi: <https://doi.org/10.1007/s11144-013-0578-x>
17. Shagapov, V. S., Yumagulova, Y. A. (2016). Automodel problem of the growth of the hydrate particle in aqueous solution of gas. *Theoretical Foundations of Chemical Engineering*, 50 (3), 270–272. doi: <https://doi.org/10.1134/s0040579516030118>
18. Vlasov, V. A. (2012). Phenomenological diffusion theory of formation of gas hydrate from ice powder. *Theoretical Foundations of Chemical Engineering*, 46 (6), 576–582. doi: <https://doi.org/10.1134/s0040579512060243>
19. Manakov, A. Y., Penkov, N. V., Rodionova, T. V., Nesterov, A. N., Fesenko Jr, E. E. (2017). Kinetics of formation and dissociation of gas hydrates. *Russian Chemical Reviews*, 86 (9), 845–869. doi: <https://doi.org/10.1070/rcr4720>
20. Vorotyntsev, V. M., Malyshev, V. M. (2011). Gas hydrates: nanosized phases in the separation and purification of substances by crystallization. *Russian Chemical Reviews*, 80 (10), 971–991. doi: <https://doi.org/10.1070/rc2011v080n10abeh004176>
21. Vorotyntsev, V. M., Malyshev, V. M., Vorotyntsev, I. V. (2014). High purification of gases by the hybrid gas hydrate-membrane method. *Petroleum Chemistry*, 54 (7), 491–497. doi: <https://doi.org/10.1134/s0965544114070135>
22. Pavlenko, A., Kutnyi, B., Holik, Y. (2017). Study of the effect of thermobaric conditions on the process of formation of propane hydrate. *Eastern-European Journal of Enterprise Technologies*, 5 (5 (89)), 43–50. doi: <https://doi.org/10.15587/1729-4061.2017.111409>
23. Shagapov, V. S., Tazetdinov, B. I. (2013). On the theory of the decomposition of a metastable gas hydrate. *Theoretical Foundations of Chemical Engineering*, 47 (4), 388–396. doi: <https://doi.org/10.1134/s0040579513030111>
24. Pavlenko, A., Kutnyi, B., Kugaevska, T. (2018). Research into resonance phenomena in gas-vapor bubbles. *Eastern-European Journal of Enterprise Technologies*, 1 (5 (91)), 39–47. doi: <https://doi.org/10.15587/1729-4061.2018.123957>