

This paper has investigated the nanostructured samples of zinc oxide intended for use as a gas sensor. Experimental samples were obtained by the economical sol-gel method, suitable for large-scale production. The dependence of the efficiency of gas sensors based on zinc oxide on temperature was established. The electrical properties of experimental samples were investigated in the air in the range of values of the initial voltage of 5–30 V and at temperatures of 320, 370, and 450 K.

It was established that the current-voltage characteristic for nano-sized zinc oxide is non-ohmic, but the nature of the curves can change due to an increase in the operating temperature. The obtained experimental dependences are explained by the peculiarities of the morphology of the obtained nanostructured zinc oxide, which affects the value of the contact resistance in the structure. A large number of nanoscale particles leads to an increase in the number of energy barriers, which negatively affects the sensitivity of experimental samples to the gaseous medium. The study of the sensitivity of samples to the established gaseous medium, namely 100 ppm CO, was carried out.

The electrical conductivity of zinc oxide is determined by oxygen vacancies that are electron donors, and, accordingly, the conductivity activation energy is determined by the donor levels formed by vacancies in the ZnO forbidden zone. During heating, there is a decrease in the resistance of the sample with increasing temperature; electrical conductivity is determined by the thermal generation of electrons. Understanding the dependence of the sensor sensitivity on temperature and the use of sensitive ZnO layers of different morphology will make it possible to recognize gaseous components in a complex mixture

Keywords: zinc oxide, semiconductor structure, gas sensor, sol-gel method, volt-ampere characteristic, temperature dependence, gas environment, gas analyzer, reducing gas, contact resistance

UDC 621:53.096

DOI: 10.15587/1729-4061.2022.263686

OPTIMIZATION OF THE TECHNOLOGY FOR DESIGNING SENSITIVE GAS SENSORS BASED ON ZINC OXIDE USING A SOL-GEL METHOD

Oleh Neshpor

Postgraduate Student*

Natalya Deyneko

Corresponding author

Doctor of Technical Sciences, Associate Professor
Department of Special Chemistry and Chemical Engineering**

E-mail: natalyadeyneko@gmail.com

Roman PonomarenkoDoctor of Technical Sciences, Professor
Faculty of Operational and Rescue Forces****Artem Maiboroda**

PhD, Associate Professor***

Mykhaylo Kropyva

PhD***

Oleg BlyashenkoDoctor of Technical Sciences
Ministry of Defence of Ukraine
Povitroflotskyi ave., 6, Kyiv, Ukraine, 03049**Serhii Yeremenko**

Doctor of Technical Sciences, Associate Professor*

Volodymyr Sydorenko

Doctor of Technical Sciences, Associate Professor*

Vasyl ServatyukDoctor of Military Sciences, Professor
Institute of State Military Administration
The National Defence University of Ukraine named after Ivan Cherniakhovskiy
Povitroflotskyi ave., 28, Kyiv, Ukraine, 03049**Andrii Pruskyi**

Doctor of Engineering, Associate Professor*

*Department of Fire Prevention and Life Safety of the Population
Institute of Public Administration and Research in Civil Protection
Vyshgorodska str., 21, Kyiv, Ukraine, 04074

**National University of Civil Defence of Ukraine

Chernyshevskaya str., 94, Kharkiv, Ukraine, 61023

***Department of Physical and Chemical Foundations
of Fire Development and ExtinguishingCherkasy Institute of Fire Safety named after Chernobyl Heroes
of National University of Civil Protection of Ukraine
Onoprienka str., 8, Cherkasy, Ukraine, 18034

Received date 06.06.2022

Accepted date 10.08.2022

Published date 31.08.2022

How to Cite: Neshpor, O., Deyneko, N., Ponomarenko, R., Maiboroda, A., Kropyva, M., Blyashenko, O., Yeremenko, S., Sydorenko, V., Servatyuk, V., Pruskyi, A. (2022). Optimization of the technology for designing sensitive gas sensors based on zinc oxide using a sol-gel method. Eastern-European Journal of Enterprise Technologies, 4 (5 (118)), 30–36. doi: <https://doi.org/10.15587/1729-4061.2022.263686>

1. Introduction

Currently, in 150 cities of the world, there is an excess of the maximum permissible concentration of harmful sub-

stances in the air by 5 times [1]. The presence of hazardous impurities in the air and the need to detect leakage of toxic volatile chemical components predetermine the intensive development of gas sensors – environmental monitoring

tools capable of recording gas molecules in minimal concentrations. Portable and stationary gas analyzers can be used to analyze the gas environment in workplaces in industry, to control food, in medicine for the diagnosis of diseases, and for national security and defense. Characteristic features of portable gas analyzers are considered to be small weight and size indicators, which allow them to be used in almost any workplace. For stationary gas analyzers, weight and dimensions, as a rule, are not important and are not critical but they are subject to high requirements for the stability of indications and reliability.

To solve this relevant issue, gas sensors based on metal oxides are promising due to their high sensitivity to many target gases in combination with simple manufacturing methods and their low cost. Gas sensors are divided into classes depending on the change in indicators from the concentration of the detected gas. The first class is characterized by a change in electric current or voltage in an electrochemical circuit based on metallic or semiconductor ion-selective electrodes, this is a class of electrochemical sensors. The second class is characterized by a change in the temperature of the metal spiral – thermoconductometric sensors. The third class is characterized by a change in the mass of gas-absorbing layers – PAH sensors. The fourth class of sensors includes sensors in which, during the deduction of gases, a change in conductivity occurs, that is, resistive sensors. The next class of sensors is characterized by a change in the effective charge in MDN structures – sensors based on MDN transistors. Gas sensors of resistive type are the most interesting, due to the following advantages, namely high sensitivity, low cost, small size, and detection of almost all gases and vapors at low concentrations. Of particular interest are semiconductor oxides SnO_2 , ZnO , In_2O_3 , Ga_2O_3 , TiO_2 , WO_3 , Fe_2O_3 , CeO_2 , and perovskites (BaSnO_3 , LaFeO_3 , SrTiO_3) with different morphologies due to the existing electrical properties and high reactivity of their surface [2]. The greatest focus of researchers is precisely ZnO . Analysis of zinc oxide nanostructures by the procedure reported in [3] showed the absence of a negative impact on the surrounding environment during all cycles of the vital cycle. Given its unique physicochemical properties, such as high chemical stability, high electrochemical bond coefficient, wide range of radiation absorption, and high photostability, ZnO is a promising material for creating sensitive gas analyzers of resistive type [4, 5].

However, ZnO -based resistive gas sensors have some drawbacks, such as poor selectivity and high operating temperature, which require further research and improvement.

2. Literature review and problem statement

Zinc oxide crystallizes in two main forms: hexagonal wurtzite and cubic zinc blende. At normal pressure and ambient temperature, ZnO crystallizes in the structure of wurtzite. Zinc oxide has a wide band gap (3.37 eV) and a large exciton binding energy (60 meV) [6], which is a great advantage among other metal oxides. The composition of ZnO includes inexpensive environmentally friendly components that are non-toxic [7], which in combination make it possible to detect low concentration gases, such as ethanol, benzene, nitric oxide, liquid petro-

leum gas, and other types. Since ZnO is a chemoresistive sensor, the change in its resistance strongly depends on the presence of chemisorbed oxygen ions. In addition, oxygen molecules are adsorbed on the surface of ZnO in the presence of atmospheric air. Thus, their formation occurs due to the extraction of electrons from the ZnO conductivity zone, which increases the resistance of ZnO . When reducing gases interact with chemisorbed oxygen ions on the ZnO surface, resistance decreases as oxygen ions donate free electrons to the ZnO conduction zone. In [8], the authors investigated the sensor based on ZnO nanorods. They showed high selectivity for hydrogen even at minimum concentrations and temperatures of 50 °C. However, obtaining samples using radiofrequency magnetron spraying is expensive compared to the gel sol method. The authors of work [9] investigated the effect of operating temperature on overcoming the energy barrier of activation to enhance the redox reaction, which further improves the sensitivity reaction. However, the problem faced by light-activated gas sensors, namely the low optical response, remained unresolved.

The dependence of the sensitivity of ZnO -based gas sensors on operating temperature usually requires sufficient thermal or light energy to overcome the energy barrier of activation to enhance the redox reaction. Therefore, scientists are looking for certain compromise conditions to improve the sensitivity response of such gas sensors. In addition, the surface morphology of ZnO nanostructures varies at high operating temperature. The authors of [10] synthesized porous ZnO nanoplates by a simple microwave method. An active reaction to both chlorobenzene and ethanol at different operating temperatures was observed. It was found that the reaction of the sensor decreases due to a decrease in chemisorbed oxygen ions on the surface with increasing operating temperature. The issue of selectivity of the porous gas sensor remained unresolved. Thus, the need to improve the sensitivity response, fast response, long-term stability, selectivity, and reproducibility at low operating temperature has initiated the search for optimal conditions and methods for the synthesis of ZnO films. In particular, for the synthesis of various morphologies and sizes of one-dimensional ZnO nanostructures, such as nanowires, nanorods, nanofiber, nanofilaments, nanoneedles, and nanotubes, chemical vapor-phase deposition (CVD) is used. Chemical deposition from the vapor phase is based on the transfer of vapors and deposition to the substrate. The key parameters for the deposition of ZnO nanostructures by this method usually depend on the substrate position, growth temperature, deposition time, gas flow rate, and pressure [11]. The authors of paper [12] grew two-dimensional ZnO microstructures, which include nanosheets and nanoplates, on an ITO/borosilicate glass substrate using thermal CVD applying oxygen. The scientists argued that the transition from one-dimensional to two-dimensional microstructures was due to an increase in oversaturated steam. The authors paid considerable attention to the conditions for changing the morphology of structures, however, there is no information in the article regarding the reaction of the ability of the samples obtained. Another method of synthesis of ZnO nanostructures is the hydrothermal pathway, where the growth of ZnO nanostructures occurs in an autoclave at a lower temperature compared to other synthesis methods. However, growing ZnO nano-

structures takes longer than in other methods. In [13], three-dimensional flower-shaped ZnO nanostructures grown by a hydrothermal process using zinc nitrate hexahydrate, hexamethylenetetramine (HMTA), and sodium hydroxide (NaOH) in an autoclave at 145 °C for 3–7 hours are reported. However, the issues related to studying the temperature dependence of the sensitivity of the obtained instrument structures remained unresolved. The deposition of ZnO nanostructures can also be performed using molecular beam epitaxy (MBE). In this process, the molecular flux of Zn is sprayed onto the substrate in the presence of reactive oxygen. The entire deposition process is carried out in an ultra-high vacuum chamber. However, the method requires high costs for equipment and maintenance, and the growth rate is slow.

The sol-gel method is of great interest due to the simplicity of technical implementation, low temperatures, the possibility of organizing mass production and great flexibility in choosing both the initial components and methods of synthesis [14]. Varying the nature of precursors, modifying substances and conditions makes it possible to synthesize dispersed ZnO forms with different morphology and sizes. The sol-gel method involves the hydrolysis or alcoholization of the precursor dissolved in solvents. The formation of ash occurs due to hydrolysis or alcoholization, and the process of re-condensation and aging is responsible for the formation of the gel. Subsequently, the materials are dried, sintered, and undergo other processes in accordance with the requirements of nanostructures [15]. Usually, precursor materials are metal salts or inorganic salts. The authors of work [16] obtained thin films of zinc oxide (ZnO) by a sol-gel method, followed by annealing at temperatures of 300, 400, and 500 °C. It was established that the annealing temperature had an 84.53 % effect on the size of the crystals of the resulting films. The paper demonstrates the effect of exposure time (18, 24, and 48 hours), temperature annealing (300, 400, and 500 °C) and rotational speed (1500, 2500, and 3500 rpm) on the size of crystals and the roughness of the surface of thin films. However, the dependence of the reactivity on the conditions for obtaining films by the sol-gel method has not been established.

Thus, among the studies tackling the design of gas sensors based on ZnO, the greatest attention is paid to expensive methods for obtaining sensitive semiconductor structures. All this suggests that it is advisable to conduct a study on designing sensitive gas sensors using simpler and cheaper methods, such as the sol-gel method.

Accordingly, to obtain sensitive gas sensors based on ZnO, it is necessary to optimize the physicochemical bases for the synthesis of various morphologies and sizes of ZnO nanostructures.

3. The aim and objectives of the study

The aim of this work is to optimize the technology of designing sensitive gas sensors based on zinc oxide. This will make it possible to design semiconductor gas sensors using simple methods suitable for large-scale production.

To accomplish the aim, the following tasks have been set:

- to study the electrical properties of nanostructured ZnO obtained by a sol-gel method;

- to study the sensitivity of the nanostructured ZnO obtained by a sol-gel method to the established gas medium.

4. Materials and research methods for nanostructured zinc oxide intended for use as a gas sensor

4.1. Preparation of nanostructured zinc oxide by the sol-gel method

Obtaining nanostructures of zinc oxide, intended for use as a gas sensor, by the sol-gel method requires structural and technological solutions for their design.

We grew zinc oxide nanostructures in two stages. First, the initial layer was applied to the substrates by the sol-gel method. Glass plates were used as a substrate. All substrates have previously been thoroughly cleaned by sonication, first in acetone and then in ethanol for 10 minutes.

ZnO thin films were synthesized using sol obtained by dissolving 1.5 g of zinc acetate $Zn(CH_3COO)_2$ in 8 ml of isopropyl alcohol. Maturation of the sol occurred within 2 days at room temperature (22 ± 2) °C. Isopropyl alcohol was used as a liquid medium to maintain the stability of the solution and create the required viscosity. ZnO films were applied to glass substrates by centrifugation, which implies that the precipitated layer is formed by spreading the solution under the action of centrifugal forces, and the excess solution flows from the substrate during rotation. The rotational speed of the substrate was 2000 rpm. After that, the substrates were sent to the muffle furnace and kept at a temperature of 250 °C for 5 minutes. The finishing annealing, which was carried out at a temperature of 350 °C for 60 minutes in a muffle furnace, resulted in the formation of a uniform ZnO layer on the surface of the substrate. The typical thickness of one layer according to electron microscopy was about 30–40 nm. The resulting samples with applied contacts are shown in Fig. 1.

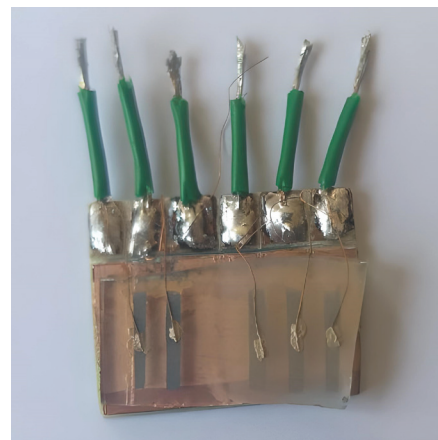

Fig. 1. General view of the resulting nanostructured sample of ZnO

For the synthesis of the obtained nanostructures of zinc oxide, a chemical precipitate of solutions of zinc salts was used. In the first case, 1 ml of ethylenediamine and 200 ml of distilled water were placed in the reaction cup. Further, with constant stirring with drops, a 0.2 molar aqueous solution of zinc acetate $Zn(CH_3COOH)_2$ was added to the ethylenediamine solution until the pH was set at 8.5. Samples with the

applied initial layer of ZnO were lowered into the resulting mixture. The closed reaction vessel was placed in a drying cabinet at a temperature of 85–110 °C for 2 hours. At the end of the synthesis, the samples were gently washed with distilled water and air-dried. The second synthesis solution was obtained by mixing 0.01 ml of zinc nitrate solutions $Zn(NO_3)_2 \cdot 6H_2O$ and hexamethylenetetramine $(CH_2)_6N_4$ in distilled water. Solutions were used in a ratio of 1:1. Substrates were located in the reaction vessels vertically. The time and temperature of exposure are similar to the first option. At the end of growth, the obtained samples were removed from the solution, washed with distilled water, and dried in air.

4. 2. Investigation of electrical properties and sensitivity of nanostructured ZnO

The studies were carried out at the installation to examine electrical properties and sensitivity; a diagram of the installation is shown in Fig. 2.

Fig. 3 demonstrates a general view of the installation for studying electrical properties and sensitivity.

To study the electrical properties, voltage measurements were carried out when the ambient temperature changes. The sample under study was placed in a tubular furnace and, heating the furnace to 450 K, recorded the indicators of the device every 10 K, recording the heating time. Formulas (1) and (2) were used to calculate the current flowing through the substrate and the resistance of the sensitive layer:

$$R = \frac{U_1}{R_r}, \tag{1}$$

where U_1 is the measured voltage value, which corresponds to the indicators of the multimeter, V; R_r – reference resistance (10 MΩ).

$$R_x = \frac{U_0 - U_1}{U_1} R_r, \tag{2}$$

where U_0 is the specified voltage value, V.

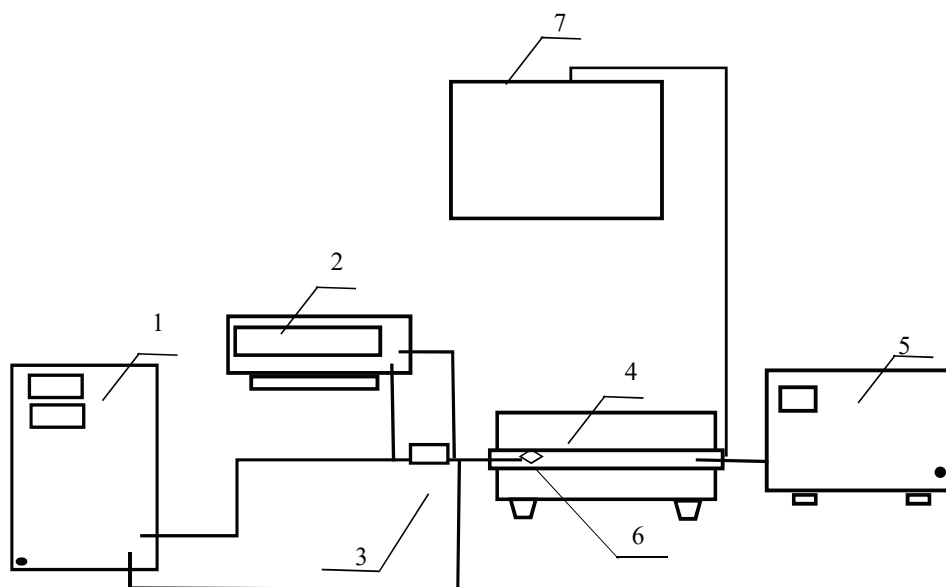

Fig. 2. Diagram of the installation for studying electrical properties and sensitivity: 1 – DC source; 2 – multimeter; 3 – reference resistance; 4 – furnace; 5 – thermostat; 6 – the sample under study; 7 – installation for creating a gas atmosphere

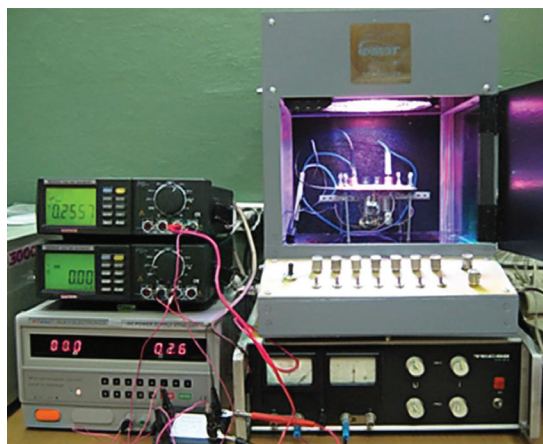

Fig. 3. General view of the installation for studying the electrical properties and sensitivity of the sample [17]

To determine the sensitivity of samples to the established gaseous medium, namely 100 ppm CO, studies of the obtained samples were carried out at a relative humidity of 50 %. It is known that after one hour of staying in rooms whose air contains only 0.1 % CO, a person loses consciousness. When the concentration of CO in the premises is at the level of 0.5 %, fatal poisoning occurs in 20 minutes, and at the content of 1 % – in a minute [18]. Concentrations have been chosen in a range that is of interest to conventional air quality standards. The gas cylinder was connected to the mass flow controllers. The resistance of the samples under study was stabilized by working at a temperature of 450 K under a continuous stream (1 l/min) of synthetic air for several hours. The sample was then exposed to a gas of 100 ppm CO at a temperature of 450 K. Relative humidity was maintained at 50 %, and the total gas flow rate was 1 l/min.

5. Results of studying the nanostructured ZnO intended for use as a gas sensor

5.1. Results of studying the electrical properties of nanostructured ZnO obtained by a sol-gel method

According to the results of our studies, volt-ampere characteristics (VAC) were built. By the type of VAC, one can evaluate the response of the sensor element in the air. The obtained volt-ampere characteristics of the studied sample of zinc oxide in pure air in the range of values of the initial voltage of 5–30 V at temperatures of 320, 370, and 450 K are shown in Fig. 4.

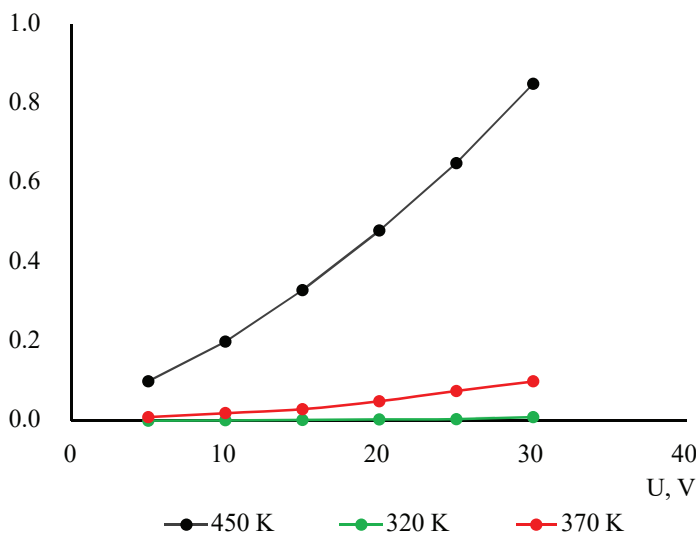

Fig. 4. Volt-ampere characteristics of nanostructured zinc oxide samples

Fig. 4 demonstrated that the volt-ampere characteristics of nanoscale zinc oxide are non-ohmic in nature, that is, the nonlinear dependence of the voltage drop on the sample on the current flowing in it. This nature of the

volt-ampere characteristics is observed at temperatures of 320 K and 370 K. At a temperature of 450 K, a change in the shape of the volt-ampere characteristic towards linear dependence is observed, and the current-voltage characteristics demonstrate an ohmic character.

5.2. Results of studying the sensitivity of nanostructured ZnO obtained by a sol-gel method to the established gas medium

The results of our study on the sensitivity to reducing gas, namely 100 ppm CO in the temperature range of 450–320 K, are shown in Fig. 5.

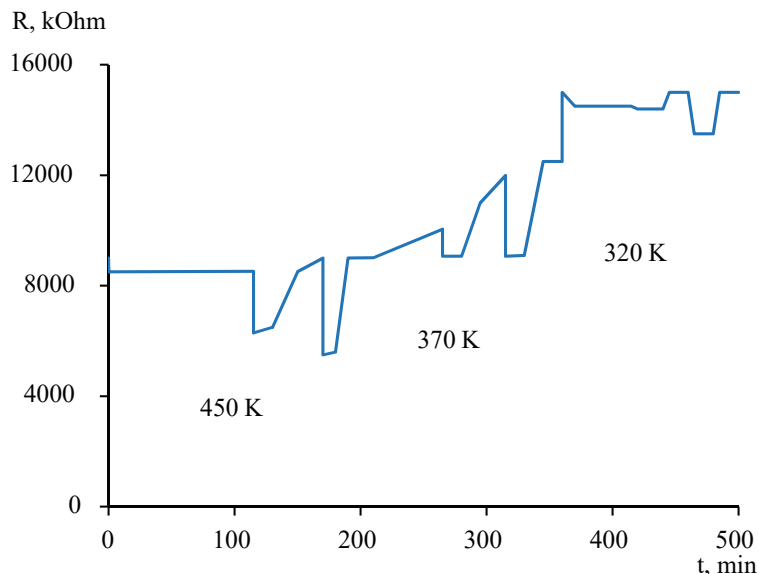

Fig. 5. Response of the nanostructured zinc oxide samples to CO reducing gas with a concentration of 100 ppm

Fig. 5 demonstrates the dependence of the resistance of the sample when it is heated over time. Under the influence of CO at a temperature of 450 K, a decrease in the resistance of the gas sensor is observed. When the gas approaches the surface of ZnO, the oxygen adsorbed on the surface interacts with the molecules of this gas and releases the captured electrons back into the conduction zone, causing a decrease in the resistance of the sensor.

6. Discussion of results of studying the nanostructured ZnO obtained by a sol-gel method

The obtained experimental volt-ampere characteristics of zinc oxide in pure air in the range of values of the initial voltage of 5–30 V at temperatures of 320, 370, and 450 K are explained by the peculiarities of the morphology of the sample under study. The electrical properties of zinc oxide obtained by the sol-gel method are affected by an increase in temperature in the form of a change in the value of the contact resistance in the structure. The contact resistance depends on the number of contacts between the particles, which is the largest in the case of nano-sized particles in comparison with other morphological varieties of zinc oxide. Since in the case of nanoscale particles the number of contacts is greater, there-

fore, the number of energy barriers is also greater. The ohmic behavior of volt-ampere characteristics is very important for the sensory properties of the material since the sensitivity of the sensor element is maximum for ohmic semiconductors. Determining the temperature at which the current-voltage characteristics of a gas sensor based on ZnO obtained by a sol-gel method is ohmic in nature (Fig. 4) makes it possible to proceed to further studies of the influence of morphology on the reactivity of such samples. The gas sensors studied in the work demonstrated reactivity at lower temperatures than that in [14], which is due to optimally selected conditions for obtaining samples.

The undeniable result is that the samples of nanostructured zinc oxide demonstrate sensitivity to gas exposure at a temperature of 450 K. As can be seen from Fig. 5, when the temperature drops to 320 K, the response to the effects of gas is significantly reduced. Changes in electrical resistance in the samples under study occur when gas molecules react to their surface. During exposure to air, oxygen molecules are adsorbed on the ZnO surface, capturing electrons from the conduction band, which leads to the formation of a depleted layer and, thus, increases the resistance of the sensor. The type of oxygen adsorbed forms (O_2^- , O^- , O^{2-}) depends on operating temperature, which can be described by reactions (1) to (4):

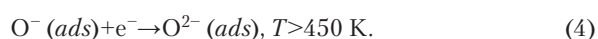
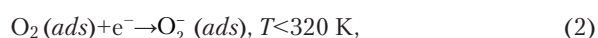
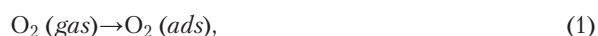

When the test gas reaches the ZnO surface, the oxygen adsorbed on the surface interacts with the molecules of

this gas and releases the captured electrons back into the conduction zone, causing a decrease in the resistance of the sensor. During heating, there is an increase in reactivity and, accordingly, sensitivity due to the additional thermal generation of electrons.

Therefore, based on this, to increase the sensitivity of zinc oxide to the gaseous medium, and to increase the prospects for using such material to design gas sensors, further studies of other morphological types of zinc oxide obtained by the sol-gel method are necessary.

This approach will be implemented in further scientific research aimed at designing a selective gas sensor.

7. Conclusions

1. Studies of the electrical properties of nanostructured ZnO obtained by the sol-gel method have been carried out. By the nature of the volt-ampere characteristics, it was established that at a temperature of 450 K there is a transition to an ohmic nature and, accordingly, the sensitivity of the gas sensor increases.

2. Studies of the sensitivity of the nanostructured ZnO obtained by a sol-gel method to a certain gas medium, 100 ppm CO, were performed. It was found that stable sensitivity to reducing gases is observed in the temperature range of 380–450 K.

Conflict of interests

The authors declare that they have no conflict of interest in relation to this research, whether financial, personal, authorship or otherwise, that could affect the research and its results presented in this paper.

References

1. Pospelov, B., Rybka, E., Meleshchenko, R., Borodych, P., Gornostal, S. (2019). Development of the method for rapid detection of hazardous atmospheric pollution of cities with the help of recurrence measures. *Eastern-European Journal of Enterprise Technologies*, 1 (10 (97)), 29–35. doi: <https://doi.org/10.15587/1729-4061.2019.155027>
2. Paraguay D., F., Miki-Yoshida, M., Morales, J., Solis, J., Estrada L., W. (2000). Influence of Al, In, Cu, Fe and Sn dopants on the response of thin film ZnO gas sensor to ethanol vapour. *Thin Solid Films*, 373 (1-2), 137–140. doi: [https://doi.org/10.1016/s0040-6090\(00\)01120-2](https://doi.org/10.1016/s0040-6090(00)01120-2)
3. Vambol, S., Vambol, V., Sychikova, Y., Deyneko, N. (2017). Analysis of the ways to provide ecological safety for the products of nanotechnologies throughout their life cycle. *Eastern-European Journal of Enterprise Technologies*, 1 (10 (85)), 27–36. doi: <https://doi.org/10.15587/1729-4061.2017.85847>
4. Lv, Y., Guo, L., Xu, H., Chu, X. (2007). Gas-sensing properties of well-crystalline ZnO nanorods grown by a simple route. *Physica E: Low-Dimensional Systems and Nanostructures*, 36 (1), 102–105. doi: <https://doi.org/10.1016/j.physe.2006.09.014>
5. Vanalakar, S. A., Patil, V. L., Harale, N. S., Vhanalakar, S. A., Gang, M. G., Kim, J. Y. et. al. (2015). Controlled growth of ZnO nanorod arrays via wet chemical route for NO₂ gas sensor applications. *Sensors and Actuators B: Chemical*, 221, 1195–1201. doi: <https://doi.org/10.1016/j.snb.2015.07.084>
6. Jia, X., Fan, H., Afzaal, M., Wu, X., O'Brien, P. (2011). Solid state synthesis of tin-doped ZnO at room temperature: Characterization and its enhanced gas sensing and photocatalytic properties. *Journal of Hazardous Materials*, 193, 194–199. doi: <https://doi.org/10.1016/j.jhazmat.2011.07.049>
7. Dar, G. N., Umar, A., Zaidi, S. A., Ibrahim, A. A., Abaker, M., Baskoutas, S., Al-Assiri, M. S. (2012). Ce-doped ZnO nanorods for the detection of hazardous chemical. *Sensors and Actuators B: Chemical*, 173, 72–78. doi: <https://doi.org/10.1016/j.snb.2012.06.001>
8. Kumar, M., Singh Bhati, V., Ranwa, S., Singh, J., kumar, M. (2017). Pd/ZnO nanorods based sensor for highly selective detection of extremely low concentration hydrogen. *Scientific Reports*, 7 (1). doi: <https://doi.org/10.1038/s41598-017-00362-x>

9. Ranwa, S., Kulriya, P. K., Sahu, V. K., Kukreja, L. M., Kumar, M. (2014). Defect-free ZnO nanorods for low temperature hydrogen sensor applications. *Applied Physics Letters*, 105 (21), 213103. doi: <https://doi.org/10.1063/1.4902520>
10. Jing, Z., Zhan, J. (2008). Fabrication and Gas-Sensing Properties of Porous ZnO Nanoplates. *Advanced Materials*, 20 (23), 4547–4551. doi: <https://doi.org/10.1002/adma.200800243>
11. Yang, C., Wu, P., Gan, W., Habib, M., Xu, W., Fang, Q., Song, L. (2016). Low temperature CVD growth of ultrathin carbon films. *AIP Advances*, 6 (5), 055310. doi: <https://doi.org/10.1063/1.4949755>
12. Tuayjaroen, R., Jutarosaga, T. (2017). The influence of oxygen partial pressure on the shape transition of ZnO microstructure by thermal evaporation. *Thin Solid Films*, 631, 213–218. doi: <https://doi.org/10.1016/j.tsf.2017.04.023>
13. Umar, A., Akhtar, M. S., Al-Hajry, A., Al-Assiri, M. S., Almehbad, N. Y. (2012). Hydrothermally grown ZnO nanoflowers for environmental remediation and clean energy applications. *Materials Research Bulletin*, 47 (9), 2407–2414. doi: <https://doi.org/10.1016/j.materresbull.2012.05.028>
14. Pawar, R. C., Lee, J.-W., Patil, V. B., Lee, C. S. (2013). Synthesis of multi-dimensional ZnO nanostructures in aqueous medium for the application of gas sensor. *Sensors and Actuators B: Chemical*, 187, 323–330. doi: <https://doi.org/10.1016/j.snb.2012.11.100>
15. Znaidi, L. (2010). Sol–gel-deposited ZnO thin films: A review. *Materials Science and Engineering: B*, 174 (1-3), 18–30. doi: <https://doi.org/10.1016/j.mseb.2010.07.001>
16. Chavan, A., Shivaraj, B. W., Murthy, H. N. N., A, V., Holla, V., Shandilya, S. et. al. (2015). Parametric Study of Sol Gel Technique for Fabricating ZnO Thin Films. *Procedia Materials Science*, 10, 270–278. doi: <https://doi.org/10.1016/j.mspro.2015.06.050>
17. Deyneko, N. (2020). Study of Methods for Producing Flexible Solar Cells for Energy Supply of Emergency Source Control. *Materials Science Forum*, 1006, 267–272. doi: <https://doi.org/10.4028/www.scientific.net/msf.1006.267>
18. Pospelov, B., Andronov, V., Rybka, E., Meleshchenko, R., Borodych, P. (2018). Studying the recurrent diagrams of carbon monoxide concentration at early ignitions in premises. *Eastern-European Journal of Enterprise Technologies*, 3 (9 (93)), 34–40. doi: <https://doi.org/10.15587/1729-4061.2018.133127>