

*The object of this study are ways to ensure the speed and repeatability of the valve for the release of combustion products from the thermal-pulse unit, which are the most important parameters that enable the precision of the finishing treatment with detonating gas mixtures. The study is aimed at analyzing the process of releasing combustion products in the valve of the proposed design; identification of factors that affect the speed of its opening; establishing the nature of the change in gas dynamic parameters in the combustion chamber. Experimental studies were carried out on a specialized bench simulating the operation of a valve with pressure measurement in gas cavities and controlling the movement of a movable glass of the valve with an incremental encoder. Information on the position of the movable cup is obtained in real time with a decisive ability of 3 microns. The experimental study showed that an increase in the response rate of the valve of the design under consideration to the values required for precision thermal pulse treatment (0.01 s) is possible subject to the use of compressed air. To study the flow processes of high-temperature gases during the operation of the controlled outlet valve, partially immersed in water, a numerical model has been built. A feature of the model is to take into account the real values of the friction force acting on the moving part of the valve, due to the introduction of resistance force acting on the movable glass. The magnitude of this force under the specified initial conditions is assigned from the condition of ensuring the coincidence between the estimated opening time of the valve and its average value obtained from full-scale experiments. For the range of design conditions, based on the lower limit of the working pressure of the combustion products, the water level is determined in the chamber of the thermal pulse equipment, on which the valve must be partially immersed for safe operation*

**Keywords:** TEM processing, managed release, numerical modeling, digital twin

UDC 66.071.4:66.084.2

DOI: 10.15587/1729-4061.2022.267798

# CONSTRUCTIONS OF THE EXPERIMENTAL-ESTIMATION MODEL FOR RELEASING COMBUSTION PRODUCTS AT THERMAL PULSE PROCESSING

**Oleg Tryfonov**

PhD, Associate Professor\*

**Olga Shypul**

PhD, Associate Professor\*

**Sergiy Plankovskyy**

Doctor of Technical Sciences, Professor

Department of Automation

and Computer-Integrated Technologies

O. M. Beketov National University

of Urban Economy in Kharkiv

Marshal Bazhanov str., 17, Kharkiv, Ukraine, 61002

**Vadym Garin**

Corresponding author

PhD, Senior Researcher\*

E-mail: v.garin@khai.edu

\*Department of Aircraft Manufacturing

National Aerospace University

«Kharkiv Aviation Institute»

Chkalova str., 17, Kharkiv, Ukraine, 61070

Received date 13.09.2022

Accepted date 14.11.2022

Published date 30.12.2022

**How to Cite:** Tryfonov, O., Shypul, O., Plankovskyy, S., Garin, V. (2022). Constructions of the experimental-estimation model for releasing combustion products at thermal pulse processing. *Eastern-European Journal of Enterprise Technologies*, 6 (1 (120)), 6–15. doi: <https://doi.org/10.15587/1729-4061.2022.267798>

## 1. Introduction

A constant trend in the development of mechanical engineering is to increase the accuracy of parts processing, their miniaturization, and the systematic introduction of automation tools at all stages of the production cycle. Reducing the size of parts of high-precision mechanisms leads to minimization of gaps in friction pairs, which in turn puts forward more and more stringent requirements for the quality of finishing edges and cleaning the surfaces of precision parts.

Among the numerous methods of finishing edges and surfaces, non-deformation technologies stand out. Their absolute advantage is that, unlike traditional blade and abrasive methods, they do not lead to secondary defects of the surfaces of precision parts. Among these methods, special attention

should be paid to the methods of processing by gas mixtures combustion products. The advantage of such methods is the ability to treat parts of any shape, including those that have complex internal cavities. When using them, it is possible to combine simultaneous machining of the edges of parts and cleaning of their surfaces. Given that such methods are the most productive among all edge finishing methods, all this makes them the most obvious for use in finishing operations of automated production.

The rapid development of additive production methods also contributes to an increase in interest in the development of these methods. Parts made by additive methods are characterized by a complex geometric shape. In layer-by-layer manufacturing processes, thin technological rods are used to support parts elements. The task of automated removal of such

rods and cleaning the surfaces of parts from the particles of the powder from which they are made is extremely difficult. To solve it, one of the most promising ways is the use of finishing treatment with combustion products of gas mixtures [1–3].

Given the noted tendency to miniaturization of high-precision parts and the widespread use of thin rods and shells in the design of additive parts, one of the tasks of ensuring a stable quality of processing when using these methods is the accuracy of ensuring processing time. For this, modern equipment is equipped with a system controlled by the time of release of combustion products. Depending on the material and geometry of the workpieces, the machining time can range from tenths of a second to a few seconds. The permissible accuracy of ensuring processing time is determined by the tolerance for qualimetric edges (for example, rounding radius) and can be hundredths of a second.

The contact time of the machined parts with the combustion products of gas mixtures, the temperature of which can exceed 2000 °C, can significantly affect the quality of treatment. If this time is exceeded, it is possible to curvature the geometry of parts and even crack the surface layer caused by the action of thermal stresses [4]. Taking into account the noted prospects for the use of finishing treatment with combustion products of gas mixtures, the scientific studies to ensure its guaranteed quality are important. The results of such studies are necessary for practice because the system of production of combustion products plays a key role in the finishing of precision parts. Ensuring its reliability and controllability requires taking into account the peculiarities of the processes associated with its work. For this, it is promising to use a numerical experiment using adequate mathematical models. The problem of building such a model in relation to the process of high-speed release of combustion products is considered in this paper.

## 2. Literature review and problem statement

Methods of finishing with combustion products of gas mixtures are promising processes for processing edges, removing burrs, and cleaning the surfaces of precision parts of complex shape. Their typical industrial application includes finishing of engine and pump unit housings, aircraft engine components, pneumatic valves, etc. [1]. From these methods, the pulsed thermal-energy method (PTEM) [2] stands out, which is a modification of the basic version of the thermal-energy method (TEM), developed by Bosch GmbH specialists [3]. The key difference between PTEM is the use of controlled rapid release of combustion products [5]. Due to this, for PTEM time is an additional controlled processing parameter. This makes the process more flexible and makes it possible to process parts from materials with a low melting point, even made of various plastics.

Stable and repeatable quality of finishing when using PTEM processes is provided by the system of controlled release of combustion products. Such a system should ensure the release of combustion products with a temperature that can exceed 2000 °C and an initial pressure that can reach 15 MPa. PTEM processing time can range from a few tenths of a second to a few seconds, mainly depending on the material of the part. In this

case, both the total processing time and the opening time of the exhaust valve are important. For example, when processing edges, the processing time determines the radius of rounding, and the stability of the opening time of the exhaust valve determines the execution error of the specified radius. Taking into account modern requirements for tolerances of the radius of rounding of the edges, the response time of the valves for the release of combustion products should be provided at the level of up to 0.01 s [2]. This in itself is a complex engineering task but it is even more complicated by the need to protect sealing surfaces from the high-speed flow of hot gases.

The first attempts to create a system for the release of combustion products during PTEM processing to some extent copied the solutions tested in the designs of pulsed machines with a gas-air drive. In these machines, the locking device of the combustion chamber was the most responsible and complex unit.

The locking-throughput device (Fig. 1) is a pneumatic-hydraulic valve mechanism of differential type, of automatic action, the basis of which is a cylindrical sleeve with a row of radial windows in its upper part [6].

In this way, the valve for the release of combustion products, which was used on pulsed machines, opened automatically upon reaching a predetermined pressure level. With PTEM processing, this method of opening is unacceptable since the treatment requires exposure of the mixture in the chamber for a time sufficient to perform the processing or cleaning operation.

In some TEM machines, in the design of the valve for the release of combustion products, a cylindrical central protrusion at the end of the moving part of the valve was used to protect the sealing surfaces from high-temperature flow (Fig. 2) [7]. The sealing of the valve was provided by a sealing complex, which included an inner and outer ring made of bronze or stainless steel and a central liner made of deformable Teflon. When closing the sealing surfaces, the complex was in a state of comprehensive compression and ensured the tightness of the chamber. However, this design remained like the previous one not reliable enough.

In addition, the design of the BOSCH valves has a drawback due to the fact that high pressure in the control cylinder is required to ensure the sealing of the valve during the duty cycle. This is due to the fact that the direction of action of the pressure of combustion products on the moving part of the valve and the direction of its opening coincide. For this reason, a valve of this design cannot have high speed and cannot be considered as a prototype for creating a controlled exhaust valve for PTEM processing.

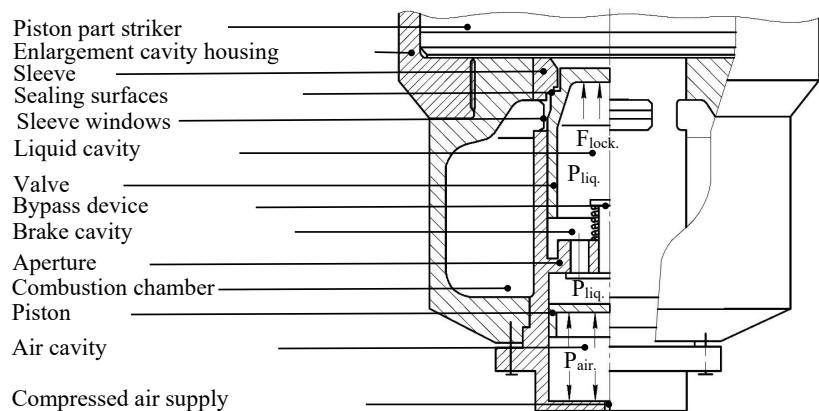

Fig. 1. Circuit of locking-throughput device

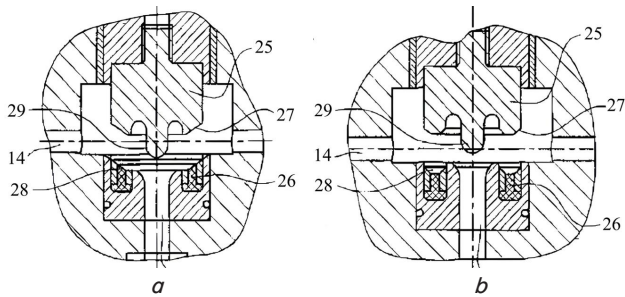

Fig. 2. Variants of the valve for the rapid release of combustion products from BOSCH [3] (numbering is preserved according to the patent): *a* – a variant with a high piston fit; *b* – option with a low piston fit; 14 – opening of the mixing chamber; 25 – mushroom-like valve pusher; 26 – valve seat; 27, 28 – beveled contact surfaces; 29 – central pin

The disadvantages of the considered structure of the controlled release valve are eliminated as follows. First, the combustion products in this valve are released through windows made in the central part in the direction perpendicular to the opening of the locking glass (Fig. 3) [8]. Due to this, regardless of the amount of pressure in the chamber, the valve opens with ordinary network pressure of air at a level of 0.6–0.7 MPa.

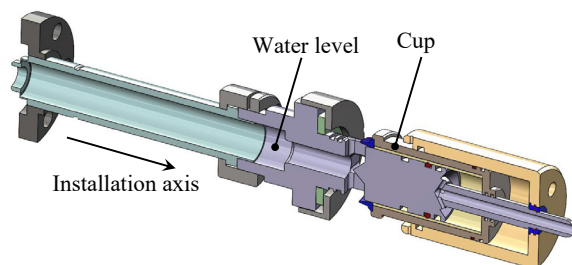

Fig. 3. Controlled release valve of PTEM installation

Secondly, the valve uses water protection. It is installed vertically along the axis of the chamber and at the same time partially located under the surface of the water that fills the tank at the bottom of the PTEM installation. The movable closing glass of the valve forms two air cavities with its body parts. When compressed air is supplied to the lower cavity, the upper one connects to the atmosphere and the valve closes, sealing the chamber. When switching oppositely, the valve opens. At the same time, the speed of opening the valve should be sufficient for the sealing cup to completely pass the access windows, remaining protected by water, until it is expelled from the central cavity by combustion products.

The problem of using the valve of the described design is the insufficient speed of its operation during opening with compressed air. In cases where the processing time is tenths of a second, this requires a signal to open the valve even before the gas mixture is ignited in the working chamber. Such a solution requires ultra-reliable synchronization of the operation of ignition and controlled exhaust systems. On the other hand, it is potentially dangerous because it can lead to the leakage of the fuel mixture from the working chamber with the occurrence of an emergency. The solution to this problem may be the use of numerical control systems built on the basis of digital twins of the system of controlled release of combustion products. As noted in [9], this approach can ensure the safe operation of controlled equipment. When building such digital twins, it is necessary to consider both

the operation of the exhaust valve itself and the pneumatic system that controls it. To do this, it is advisable to use mixed 1d–3d models [10], and the work of the control pneumatic system is modeled in 1d statement, and the valve – in 3d.

Creating an adequate numerical 3d model of the exhaust valve is a key task of building a basic model of the digital twin of the system of controlled release of combustion products in PTEM processes.

In a number of studies, for example [11], using numerical modeling, the operation of a pulse valve in a water medium is investigated. Various variants of numerical models built in ANSYS are considered, and data from field experiments are used to verify the models. Obviously, such models cannot be used to simulate an exhaust valve in PTEM processes operating in a gas-liquid environment.

Works [11, 12] consider modeling of two-phase gas-liquid flows with supersonic gas leakage but they do not consider cases of leakage of gases of high temperature and pressure, which is characteristic of the controlled valve for the release of PTEM equipment.

Thus, the study is aimed at building an adequate mathematical model of the process of releasing high-temperature gases through the equipment developed by the PTEM valve, partially immersed in water, taking into account the friction force determined in an experimental way. Such a model can be the basis for building a digital twin system of controlled release of combustion products and its subsequent use of equipment for building an algorithm for the operation of the PTEM numerical control system. A key element of such a digital twin is the numerical model of the high-speed gas release valve.

### 3. The aim and objectives of the study

The purpose of the study is to develop a numerical model of the operation of the valve for the rapid release of high-temperature gases, as a basis for building a digital twin of the system of controlled release of combustion products in the equipment for PTEM processing. This will make it possible to modernize the numerical software control system of such equipment and ensure its stable and safe operation with a processing time from  $\sim 10^{-1}$  to  $\sim 10^0$  s.

To accomplish the aim, the following tasks have been set:

- to determine the key parameters of the combustion products release process to ensure the exact time of thermal pulse processing based on experimental studies of the controlled exhaust valve;
- to perform mathematical modeling of the process of high-speed release of high-temperature gases during the operation of a valve partially immersed in water, and adjust the developed mathematical model taking into account the parameters determined at the stage of experimental research;
- to determine the peculiarities of the flow of the process of releasing high-temperature gases in the valve of the researched design and the nature of the change of operating parameters in the combustion chamber during numerical experiments based on the constructed model.

### 4. The study materials and methods

#### 4. 1. Object and hypothesis of research

The object of the study are ways to ensure the speed and repeatability of the valve for the release of combustion pro-

ducts of the thermopulse unit, which are the most important parameters that ensure the precision of the finish treatment with detonating gas mixtures. The hypothesis of the study is the assumption of the possibility of constructing an adequate model of the valve of controlled release of combustion products based on numerical modeling, taking into account the data of full-scale experiments to adjust the parameters of the numerical model. This will be the basis for building a digital twin system of controlled production of combustion products and creating on its basis an upgraded numerical control system that will ensure stable and safe operation of PTEM equipment.

#### 4. 2. Subject of research

The subject of the study are the processes associated with the operation of the valve of the controlled release of combustion products of equipment for PTEM processing.

When conducting full-scale experiments, a sample valve for controlled exhaust of the T-15 thermal pulse unit (Ukraine) was used. For research, a specialized bench was used, which simulated the operation of the valve for the release of combustion products. Valves were used to control the gas supply at the bench (Burkert 6240, Bürkert GmbH & Co. KG, Ingelfingen, Deutschland). In the course of the research, pressure was measured in the gas cavities of the valve and the movement of the movable valve cup. Pressure sensors (TSZ-6002-G-S-20-X(G1\4)-1-K-QV-Q0, Meret, Slovakia, Accuracy 0.08 %..0.25 %) were used to measure pressure. The movements of the movable cup were determined using an incremental encoder (Autonics E30S4-3000-6-L-5, USA, 3000 pulses per rotation). Information on the position of the movable cup was obtained in real time due to the formation of pulses at each change in position (the determining ability of the measuring system is 3 microns).

When constructing a numerical model of a controlled output valve, classical methods of mathematical modeling of two-phase currents in problems with moving boundaries were used. When building a mathematical model, some simplifications are accepted. Due to the transience of the processes inherent in the operation of the controlled release valve of the PTEM equipment, the simulation did not take into account the heating of the structural elements of the valve and the associated processes of thermal expansion. This made it possible to set the structural elements of the valve as fixed or movable (for the case of a glass) walls without sliding with a constant temperature. This took into account the mass of the moving element of the valve. Also, due to the symmetry of the calculated region, the following simplification is adopted: only half of the area for assigning symmetric boundary conditions is considered.

To build a numerical model of the controlled exhaust valve and conduct numerical experiments, a licensed ANSYS package (CFX module) was used.

### 5. The results of research on the process of high-speed release of combustion products

#### 5. 1. Determination of key parameters of the process of controlled release of combustion products through the valve based on experimental studies

One of the most important parameters that ensure the precision of thermal pulse treatment with detonating gas mixtures is the accuracy of the valve for the release of com-

bustion products. The duration of processing can be from hundredths to tenths of a second and should be set with an accuracy of 0.01 s. The valve has a pneumatic drive, its opening and closing is carried out by filling it with pressurized air, respectively, chambers 1 and 2 (Fig. 4).

Air supply, in turn, is carried out using electric valves. In the initial state, the valve is closed. When air is supplied to chamber 1, the movement of the moving part of the valve, the opening of windows and the release of combustion products begin. At the end of the working process, to return the valve to its original position, air is supplied to chamber 2. The experimental study was carried out on the designed generator of the gas mixture of the automated thermopulse complex [13], in particular, the unit for filling the intermediate tank with one component of the gas mixture, namely nitrogen, was used. The scheme of the experimental node of the generator of the mixture, which includes: the supply line of the component to the generator, the gas supply line to the tank with the actuator valve is shown in Fig. 4.

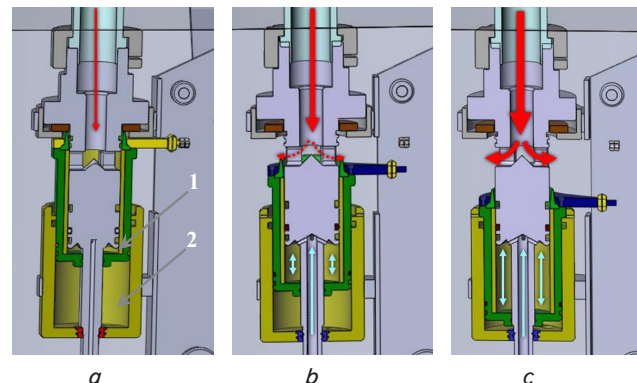

Fig. 4. The principle of operation of the exhaust valve:  
a – the valve is closed; b – air supply, valve opening;  
c – valve open

Control over the valve opening process was carried out using an incremental encoder, the principle of which is to form pulses during the rotation of the shaft. For the experiments, a bench was designed containing a valve with a connected encoder, control electric valves, as well as data recording equipment (Fig. 5). The encoder is connected to the moving part of the valve by means of a wire transmission (Fig. 6).

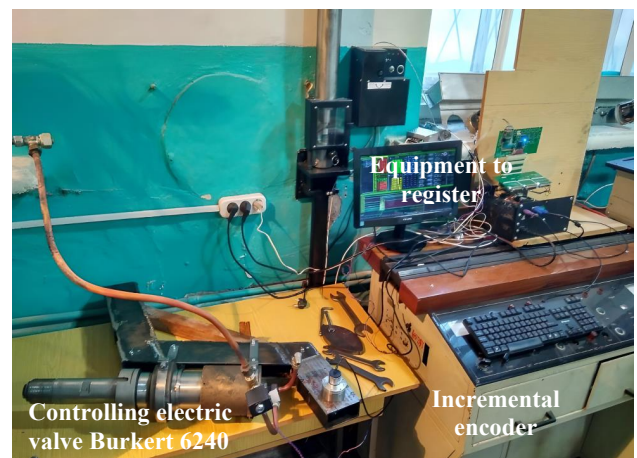

Fig. 5. Bench of experimental tests

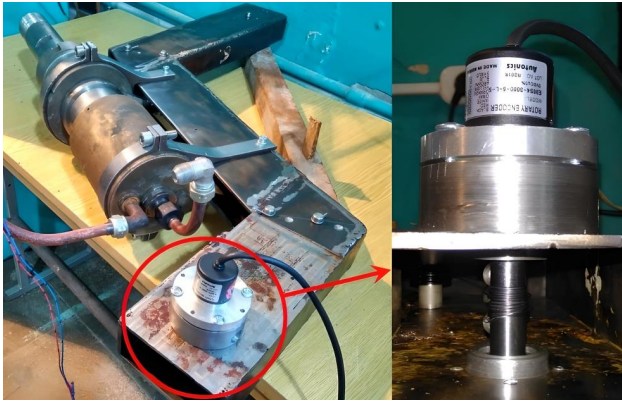

Fig. 6. Valve design with incremental encoder installed

The amount of pressure in the working chamber does not affect the opening time of the valve of the studied structure because this pressure does not affect the movement of the movable cup. This fact allowed the study to be carried out on an experimental bench, where the working chamber of the PTEM equipment was imitated by a tank filled with nitrogen. To maintain a constant pressure value in the tank, it was connected to a high-pressure nitrogen cylinder. The opening of the controlled exhaust valve, as well as on PTEM equipment, was carried out by supplying compressed air. During the experiments, the initial pressure in the nitrogen tank was maintained at 0.8 MPa, in the compressed air line of 0.5 MPa.

As a result of the experiments, it was found that at the first start of the valve under study, the opening time reaches 100 ms from the moment the signal is sent to the corresponding control valve for supplying compressed air. With further launches, this time decreases and stabilizes at a value of about 50 ms (Fig. 7).

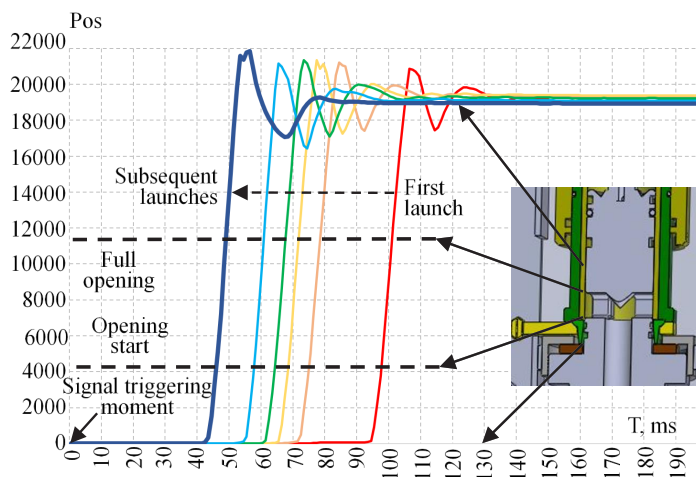

Fig. 7. Results of experiments – the dynamics of valve acceleration

In this case, the average time of opening the valve from the beginning of the movement to the completion of the opening of the bypass hole was 0.015 s. Standard deviation of the valve opening time in dynamic mode is 3.3...3.5 %. The obtained data of the opening time were subsequently used to adjust the numerical model of the process of release of combustion products.

**5. 2. Mathematical modeling of the combustion products release process**

The numerical model was built for the valve for the release of combustion products of the fuel mixture from the

PTEM equipment chamber. The design scheme of the valve was fully consistent with the sample that was investigated during full-scale experiments. The valve has four windows through which the combustion product is released. At the initial moment, the windows are closed with a piston. Under the action of compressed air, the piston is driven, opening the way for the release of combustion products. The valve is connected to the combustion chamber (Fig. 8). The valve is partially submerged in water to protect its parts from the flow of high-temperature gas.

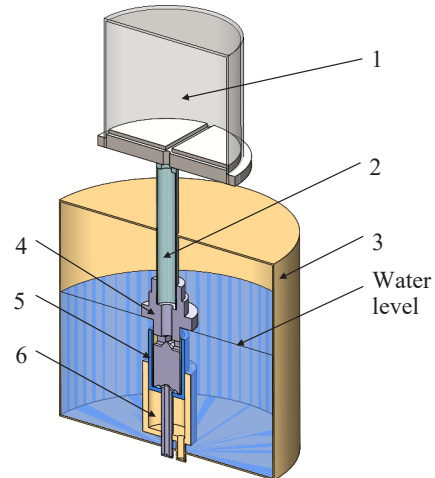

Fig. 8. Scheme of connection of the valve to the combustion chamber: 1 – combustion chamber; 2 – connecting line; 3 – water tank; 4 – exhaust valve; 5 – piston; 6 – control pressure supply chamber

When adjusting the numerical model in accordance with the conditions of full-scale experiments, the case of an overpressure of gas in the working chamber equal to 0.8 MPa was considered. The overpressure of the air opening valve is 0.5 MPa. When setting up the numerical model, as in the full-scale experiment, the dynamics of moving the moving piston was investigated. In numerical experiments, the peculiarities of the flow of combustion products and water near the valve design elements were also studied. The solution of problems in the course of numerical experiments was carried out within the calculated region, which is the internal cavity of the combustion chamber and valve.

When constructing an estimation grid around the valve, a part of the space that is partially filled with water is added to simulate its immersion in the tank. The sizes of this zone is selected as those that do not affect the pattern of flow near the exhaust windows of the valve.

In order to simplify the construction of a grid of finite elements and improve its quality, the estimation zone was cut into fragments that make it possible to build a structured grid of finite elements. Since the calculated region is symmetrical, only half of it was considered.

To solve the problem set, a combined grid of finite elements is constructed. Structured and unstructured grids were combined to reduce the number of elements without compromising the overall quality of the grid (Fig. 9).

Due to the fact that the solution of the problem is associated with modeling the movement of the edges of the

calculated region, it became necessary to rebuild the calculated grid, associated with large movements of the boundary. At this point, the deformation of the calculated area significantly reduces the quality of the grid. The restructuring of the entire computational grid requires large computational resources, so only a small part of it was highlighted, which was connected to a fixed grid using the means of a modeling system. The first, which is located below, is the control air supply zone. The second, which is located on top, is the area of combination of the outlet with the outlet windows of the valve and the water tank.

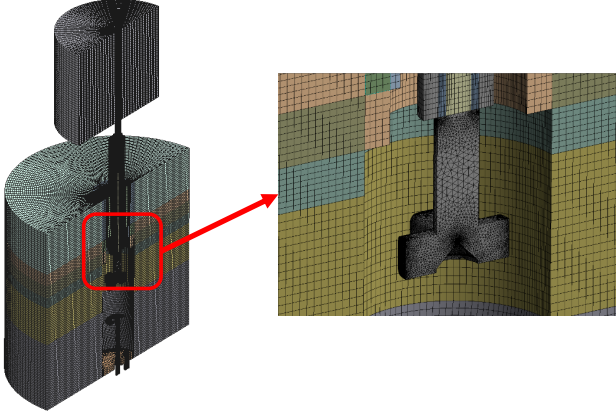

Fig. 9. Estimation grid fragment

To implement the task, the mechanism of automatic restructuring of the grid of finite elements was used. When implementing this approach, the minimum angle of the grid element along the calculated area acted as a control parameter. The grid rearrangement cycle was connected when an element appeared with an angle at a vertex of less than  $10^\circ$ . After that, a restructuring was carried out, and the calculation continued on a new grid, where, after interpolating the results from the previous iteration, the initial conditions were loaded. In general, the grid consisted of 1958076 finite elements, of which 1616107 is a structured grid.

Equations of motion in the calculated area. For the numerical study of the parameters and characteristics of the flow, a system of Navier-Stokes equations was used, which includes the laws of conservation of mass, momentum, and energy of a non-stationary spatial flow in the Cartesian coordinate system ( $x_i, i = 1, 2, 3$ ):

$$\begin{cases} \frac{\partial \rho}{\partial t} + \frac{\partial}{\partial x_k} (\rho \cdot u_k) = 0, \\ \frac{\partial (\rho \cdot u_k)}{\partial t} + \frac{\partial}{\partial x_k} (\rho \cdot u_i \cdot u_k - \tau_{ik}) + \frac{\partial P}{\partial x_i} = S_i, \\ \frac{\partial (\rho \cdot E)}{\partial t} + \frac{\partial}{\partial x_k} ((\rho \cdot E + P) \cdot u_k + q_k - \tau_{ik} \cdot u_i) = \\ = S_k \cdot u_k + Q_H, \end{cases} \quad (1)$$

where  $u_i$  – components of the velocity vector;  $\rho, p$  – density and pressure;  $S_i$  – external volumetric forces;  $E$  – total energy of the unit mass of a substance  $Q_H$  – heat released in a single volume of matter;  $\tau_{ik}$  – tensor of viscous shear stresses;  $q_i$  – heat flux.

The tensor of viscous shear stresses is defined as follows:

$$\tau_{ik} = \mu \cdot \left( \frac{\partial u_i}{\partial x_j} + \frac{\partial u_j}{\partial x_i} - \frac{2\partial u_i}{\partial x_j} \cdot \delta_{ij} \right) - \frac{2}{3} \rho \cdot k \cdot \delta_{ij}, \quad (2)$$

where  $\mu = \mu_i + \mu_t$  – viscosity coefficients;  $\mu_i$  – coefficient of molecular viscosity;  $\mu_t$  – turbulent viscosity coefficient;  $\delta_{ij}$  – Kronecker delta function;  $k$  – kinetic energy of turbulence.

To determine  $\mu_T$  and  $\lambda_T$ , in the original paper the equation of the SST-model of turbulence were used, which shows high accuracy in modeling near-wall currents [14], including under the action of shock waves [15].

In this model, the following expression is used to set the turbulent viscosity value:

$$\mu_T = \frac{\rho a_1 k}{\max(a_1 \omega; \Omega F_2)}, \quad (3)$$

where  $F_2 = \tanh(\arg_2^2)$ ;  $\arg_2 = \max\left(2 \frac{\sqrt{k}}{0.09 \omega y}; \frac{500 \nu}{y^2 \omega}\right)$  is a function equal to unity for the boundary layer and zero for the free layers;  $\Omega = (\partial u / \partial n)$  – derivative of the flow velocity in the direction of the normal to the wall. To determine the kinetic energy and its dissipation, the following equations are used:

$$\begin{aligned} \frac{\partial \rho k}{\partial t} + \frac{\partial}{\partial x_i} (\rho u_i k) = \\ = \tau_{ij} \frac{\partial u_i}{\partial x_j} - \beta \cdot \rho \omega k + \frac{\partial}{\partial x_i} \left( (\mu_i + \sigma_k \mu_t) \frac{\partial k}{\partial x_i} \right), \\ \frac{\partial \rho \omega}{\partial t} + \frac{\partial}{\partial x_i} (\rho u_i \omega) = \frac{\gamma \rho}{\mu_m} \tau_{ij} \frac{\partial \sigma_i}{\partial x_j} - \beta \rho \omega^2 + \\ + \frac{\partial}{\partial x_i} \left( (\mu_i + \sigma_\omega \mu_t) \frac{\partial \omega}{\partial x_i} \right) + 2\rho(1 - F_1) \sigma_{\omega 2} \frac{1}{\omega} \frac{\partial k}{\partial x_i} \frac{\partial \omega}{\partial x_j}, \end{aligned} \quad (4)$$

where  $\beta, \beta^*, \sigma_k, \sigma_\omega$  are empirical constants,  $F_1$  is a function that plays the role of a switch between models, so that near the wall, and at a distance from the wall,  $F_1 = 0$ . Heat flux is modeled using the following equation:

$$q_k = - \left( \frac{\mu_t}{Pr} + \frac{\mu_r}{\sigma_c} \right) c_p \frac{\partial T}{\partial x_k} + q_u, \quad (5)$$

where  $\sigma_c = 0.9$  is the empirical constant;  $Pr$  – Prandtl number;  $c_p$  – specific heat capacity at constant pressure;  $q_u$  – heat flux from radiation.

For buoyancy calculations, the initial term is added to the pulse equations as follows [16]:

$$S_m = (\rho - \rho_{ref}) \cdot \vec{g}, \quad (6)$$

where  $(\rho - \rho_{ref})$  is the difference in the density of working media,  $\vec{g}$  is the acceleration of gravity.

The pressure in the pulse equation excludes the hydrostatic gradient. This pressure correlates with absolute as follows:

$$P_{abs} = P + P_{ref} + \rho \vec{g} (\vec{r} - \vec{r}_{ref}), \quad (7)$$

where  $P_{abs}$  – absolute pressure,  $P$  – relative pressure,  $P_{ref}$  – reference pressure,  $(\vec{r} - \vec{r}_{ref})$  – determining the zone of action of hydrostatic pressure.

The force of friction when sealed with rubber rings is determined by the following formula:

$$P_{fr} = \pi \cdot D \cdot b \cdot f \cdot p_{act},$$

where  $D$  is the diameter of the piston;  $f$  – coefficient of friction;  $b$  – width of the contact zone;  $p_{act}$  – working pressure.

Using this formula to determine the friction force in practice faces uncertainty of both the friction coefficient and the width of the contact zone for the actual design of the exhaust valve and the conditions of its operation. Based on this, taking into account the friction conditions on the moving parts of the valve, an additional resistance force applied to the cup during its movement was introduced. The magnitude of this force was determined by data from full-scale experiments. To do this, at the first stage, numerical calculations of the dynamics of acceleration of the movable cup were carried out without introducing additional resistance force. According to the results of numerical calculations, a plot was built on the dependence of the acceleration of the movable cup on time. Throughout the entire valve opening time, this acceleration was higher than the data obtained from the processing of the results of full-scale experiments to measure the movement of the cup by the encoder. In this case, averaged data from full-scale experiments were used after stabilization of the valve opening time. The desired value of the additional resistance force was defined as the difference between the calculated  $a_{calc}$  and the measured  $\bar{a}_{test}$  acceleration values multiplied by the mass of the movable cup  $m_{body}$ :

$$P_{fr} = (a_{calc} - \bar{a}_{test}) \cdot m_{body} \tag{8}$$

Additionally involving the measured data on the change in the sliding speed of a movable cup over time, the force of additional resistance was defined as a function of the sliding speed  $P_{fr}(v)$ . The obtained dependence was used later to calculate the dynamics of acceleration of the movable cup in numerical modeling. Equations (1) to (8) describe the model used for the process of releasing combustion products using the valve of the design under study.

Initial and boundary conditions. The calculated area consisted of five domains:

- combustion chamber of PTEM equipment;
- control air supply device;
- the space around the valve;
- tube for air outlet from under the piston;
- part of the internal space of the valve, for which automatic restructuring of the grid of finite elements is implemented.

Part of the space around the valve is filled with protective water, as shown in Fig. 10.

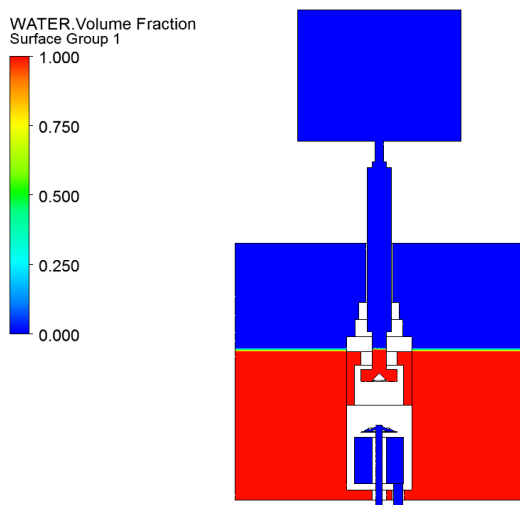

Fig. 10. Initial water level near the valve

All walls are assigned the boundary conditions of the walls without sliding. At the inlet to the control pressure supply tube, an overpressure of 0.5 MPa is set. At the edges of the space around the valve, open conditions are set with a pressure of 0.1 MPa and a water level of the same level inside the calculated area.

Since the problem with the presence of a two-phase flow with significantly different densities is solved, gravity was taken into account in all domains. The movable piston is set as a wall without sliding, which changes its position depending on the pressure of the controlling air. The mass of the piston is 1.36 kg (half of the piston is considered due to the symmetry of the calculated region).

### 5.3. Determining the properties of the process of releasing high-temperature gas according to the results of numerical experiments

At the first stage of numerical experiments, the valve opening dynamics were modeled to determine the magnitude of the additional resistance force, which takes into account the real friction conditions when the cup moves during opening. The results of this stage of calculations are shown in Fig. 11. According to these data, after 0.006 s, the upper part of the piston reaches the outlet windows, and after 0.012 s from the beginning the exhaust windows are completely open.

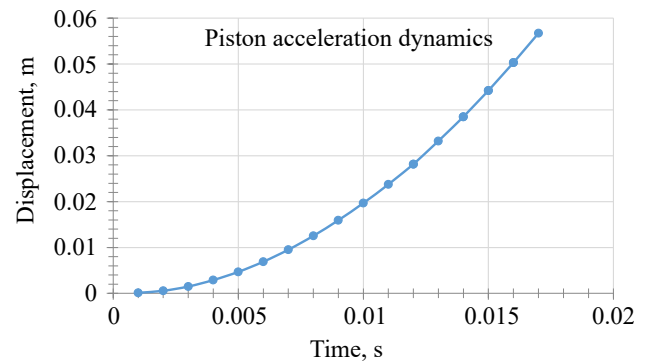

Fig. 11. Dynamics of acceleration of the movable valve cup

Based on the data of full-scale experiments, the additional resistance force applied to the movable piston was selected using formula (8), while the valve opening time increased from 0.012 to 0.015 s. The numerical model thus configured was used in further calculations.

At the second stage of numerical studies, the possibility of protecting the moving parts of the valve from the high-temperature flow of gas with the available water on the way of its opening was determined. When conducting numerical experiments to study the processes of gas flow, it was believed that at the initial moment the temperature of the combustion products is 2000 °C, and the controlling air and protective water is 20 °C. Fig. 12 shows a pattern of flow when changing the position of the lower part of the piston over time for the case of the initial pressure of gases in the chamber of 0.8 MPa.

When the valve is moved, first of all, the gas pushes out the water that is in the pipe in front of the exhaust windows of the valve. Fig. 13, 14 show the volumetric water content in the space near the valve. It is determined that gas actively pushes water out of the exhaust window zone, and the process is accompanied by intense splashing.

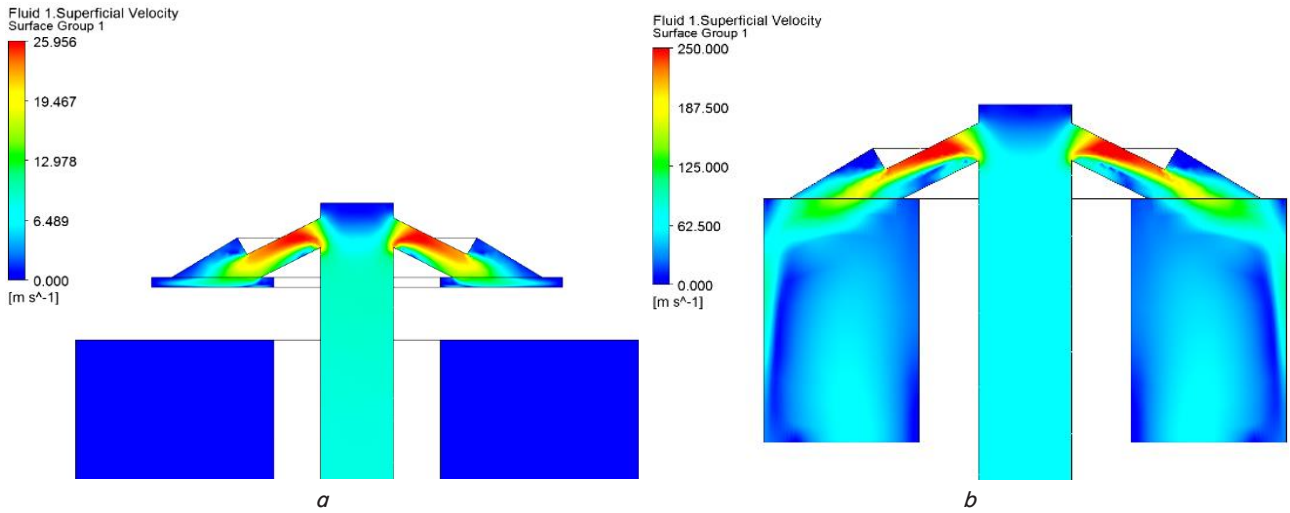

Fig. 12. Position of the bottom of the piston: *a* – 0.002 s after the supply of control air; *b* – 0.012 s after supplying control air

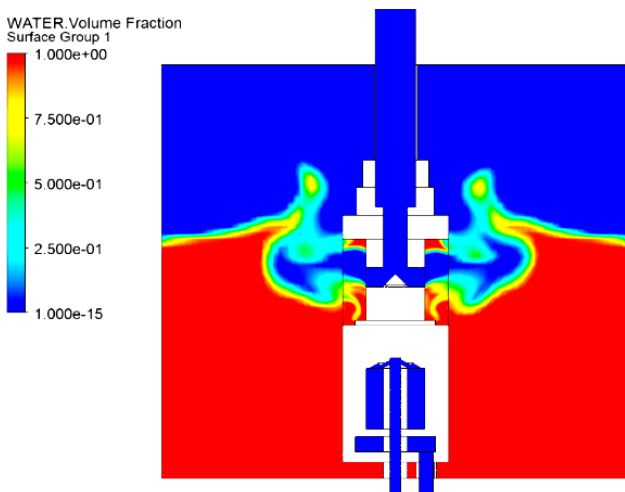

Fig. 13. Volumetric water content in the space near the valve ( $t=0.022$  s)

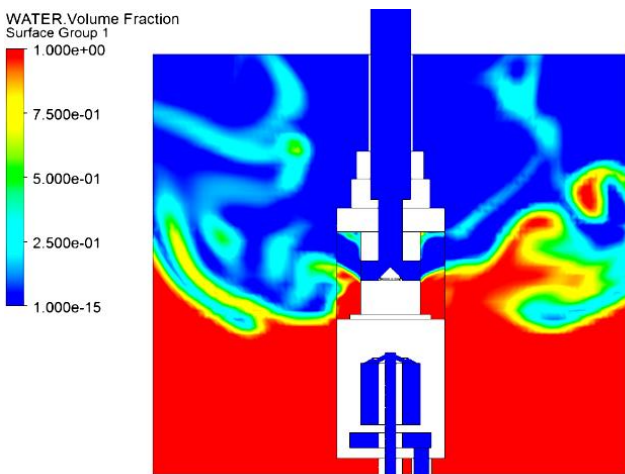
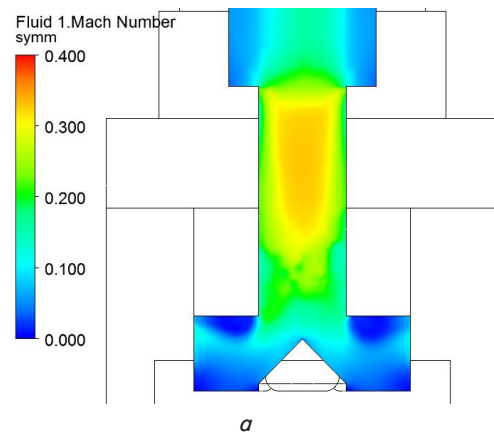
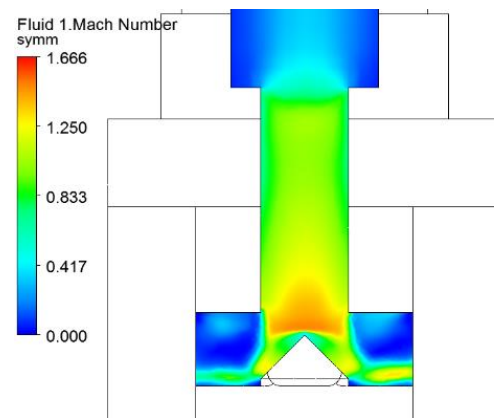

Fig. 14. Volumetric water content in the space near the valve ( $t=0.06$  s)

windows (Fig. 15, *b*) and further the pressure in the chamber drops evenly. The dynamics of pressure drop are shown in Fig. 16.



*a*



*b*

Fig. 15. Formation of flow compaction jump in front of the outlet windows: *a* – 0.004 s from the beginning of opening; *b* – 0.012 s from the beginning of opening

There is an uneven pressure drop rate when opening the valve, which lasts no more than 0.008 s. In contrast to the beginning of release (Fig. 15, *a*), starting from 0.018 s, a steady compaction jump is formed in front of the exhaust

During the numerical experiments, the position of the water level was established, at which the moving parts of the valve are protected throughout the entire process of gas leakage from the chamber.



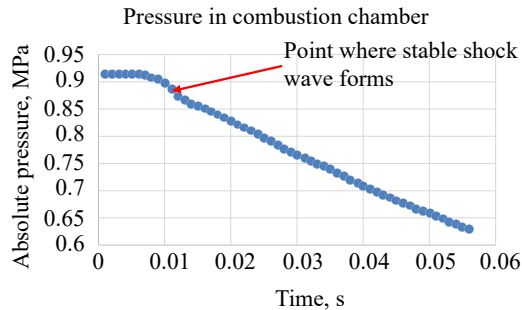

Fig. 16. Change in pressure in the working chamber

As shown in Fig. 13, 14, under the established conditions, the movable cup valve has time to fully open the access windows before contact with high-temperature combustion products. Due to the fact that the given case of the initial pressure of gases in the working chamber (0.8 MPa) is the lower limit of the operating modes, the time of release of combustion products from the chamber is minimal. With an increase in the initial pressure to 15 MPa, the moving parts of the valve at the set position of the water level remain protected from hot gases throughout the opening process.

## 6. Discussion of results of studying the controlled release valve of combustion products

The authentic experimental study showed that an increase in the response rate of the valve of the design under consideration to the values required for precision PTEM processing (0.01 s) is possible provided that pre-compressed air is used to open the valve. The instability of the valve opening time value, revealed during full-scale experiments, can be explained by a change in the friction force on the seals during operation (Fig. 7). To prevent this phenomenon, specialized sealing complexes designed for a high (~10 m/s) sliding speed should be used in the valve design.

In addition, to ensure the precision of PTEM processing before a working cycle, it is necessary to stabilize the valve operation by performing several preliminary valve starts. After stabilization of the valve, the obtained opening time values should be fixed to configure the CNC equipment system. This allows for up to ~1 ms accuracy of time compliance.

In the course of the original work, a numerical model was developed to study the flow processes of high-temperature gases during the operation of the controlled release valve of PTEM equipment partially submerged in water (formulas (1) to (8)). A feature of the developed model is to take into account the real values of the friction force acting on the moving part of the valve, the introduction of a set resistance force, which ensures the coincidence between the estimated opening time of the valve and its average value, determined by the results of full-scale experiments (8). The coordination of the numerical model with the full-scale experiment was carried out according to a parameter that can be relatively simply measured. This allows us to investigate with the use of the developed model the peculiarities of the outflow of high-temperature gases during the operation of the controlled exhaust valve, that is, to investigate the characteristics that are impossible or extremely difficult to measure (parameters of high-temperature flow and its interaction with the liquid (Fig. 12–15).

The simulation results prove the possibility of protecting the movable cup with water throughout the entire time of release of combustion products, guaranteeing its protection from exposure to high temperatures. For the calculated conditions, the water level is determined, on which the valve must be immersed in water for safe operation, based on the lower limit of the working pressure of the combustion products in the PTEM chamber of the equipment.

It is shown that the time of formation of a stable compaction jump in front of the exhaust windows, after which the pressure drop is unchanged in time (until the pressure decreases below the critical one) is commensurate with the opening time of the valve (Fig. 16). Therefore, this point requires more detailed consideration, including taking into account the characteristics of compaction of the moving parts of the valve.

In general, it can be assumed that the controlled exhaust valve for precision thermal pulse processing can be created on the basis of the valve of the described design during its modernization. To be able to continuously diagnose and improve the reliability of the valve, it must be equipped with water level sensors, sensors that record the moments of opening, closing the valve, and pressure measurement sensors in the gas cavities.

The results obtained in the original numerical studies have limitations that are due to the consideration of the separate operation of the valve from the control system for the release of combustion products. To eliminate these limitations and obtain a complete picture of the operation of the controlled output system for actuating the valve from the control signals, a numerical model of the pneumatic system should be added, including taking into account the data on the delay in the operation of the valves. Such a model can be one-dimensional since the pneumatic system consists of standard elements. In further research on the basis of the developed numerical model, it is necessary to develop a ROM model of the valve (reduced order model) and integrate it with a one-dimensional model of the pneumatic system. In fact, the general model of the exhaust control system makes it possible to determine the delay time for the start of the valve, which, according to the results of full-scale experiments, is 0.04–0.045 s (Fig. 7).

The disadvantages of the current study are associated with the impossibility of direct use of such models to build control or diagnostic algorithms in a controlled release system. They take too long to get results. The solution to the problem should be associated with the creation in the future on the basis of the described approach of ROM models and their integration with a complex of sensors within the digital twin system.

In further studies, these shortcomings are planned to be eliminated. To do this, authentic authors plan to focus on creating a digital twin controlled release system for PTEM equipment. This will ensure the possibility of implementing a safe and stable in quality precision PTEM processing.

## 7. Conclusions

1. In the course of experimental investigations of the operation of the valve for the controlled release of PTEM equipment, the peculiarity of the dynamics of valve opening was determined. As a key parameter of the process, the valve opening time from the beginning of the movement and the delay time of the beginning of its movement, which is

a characteristic of the used pneumatic valve control system, are defined.

2. A calculation-experimental model of the process of releasing high-temperature gases during the operation of the PTEM equipment valve partially immersed in water was built, which takes into account the force of friction acting on the moving part of the valve. The peculiarity of the developed model is its adjustment to match the analytical calculation and experimental measurements according to a parameter that can be measured – valve acceleration dynamics. The calculation-experimental model built can be used to study such parameters of the process that cannot be measured or are very difficult, in particular, the characteristics of the high-temperature flow, the dynamics of its interaction with the protective liquid.

3. In the course of numerical experiments on the basis of the built model, it is shown that during the release of combustion products using the valve of the studied design with an opening time at the level of 0.015 s, it is possible to implement modes when the moving part of the valve is under water all the time. Given this, the working surfaces of the valve are protected from the influence of high-temperature gas flow. For estimation conditions, the water level has been

determined, to which the valve must be immersed in water for its safe operation.

---

#### Conflicts of interest

---

The authors declare that they have no conflicts of interest in relation to the current study, including financial, personal, authorship, or any other, that could affect the study and the results reported in this paper.

---

#### Financing

---

The research was carried out within the State budget theme «Design of an experimental-industrial prototype of an automated complex for precision thermal pulse processing» (State Registration No. 0117U002500).

---

#### Data availability

---

The manuscript has no related data.

---

#### References

1. Struckmann, J., Kieser, A. (2020). Thermal deburring. ATL Anlagentechnik Luhden GmbH.
2. Plankovskyy, S., Popov, V., Shypul, O., Tsegelnyk, Y., Tryfonov, O., Brega, D. (2021). Advanced thermal energy method for finishing precision parts. *Advanced Machining and Finishing*, 527–575. doi: <https://doi.org/10.1016/b978-0-12-817452-4.00014-2>
3. Zhao, B., Wei, K., Liu, C., Liu, Q.-Y. (2013). Thermal energy deburring process for parts of hydraulic mechanism in high-voltage switchgear. *Gaoya Dianqi/High Voltage Apparatus*, 49 (3), 134–138.
4. Shypul, O., Myntiuk, V. (2020). Transient Thermoelastic Analysis of a Cylinder Having a Varied Coefficient of Thermal Expansion. *Periodica Polytechnica Mechanical Engineering*, 64 (4), 273–278. doi: <https://doi.org/10.3311/ppme.14733>
5. Bozhko, V. P., Losev, A. V., Takoriant, M. P., Pleshkov, V. I., Strizhenko, V. E., Levityansky, I. A. et al. (1989). Pat. No. US4802654A. Thermopulse Apparatus for Deburring Parts. No. 4802654. Available at: <https://patentimages.storage.googleapis.com/6e/6b/7f/767c65c6595210/US4802654.pdf>
6. Krivtsov, V. S., Botashev, A. Yu., Maznichenko, S. A. et al. (2005). Impul'snaya rezka goryachego metalla. Kharkiv: Nats. aerokosm. un-t «KhAI», 476.
7. Conrad, H.-J., Kaercher, J. (2002). Pat. No. EP1232822A1. Device for thermal deburring of a workpiece. No. 02003311.4; declared: 13.02.2002; published: 21.08.2002. Available at: <https://patents.google.com/patent/EP1232822A1/en>
8. Plankovskoho, S. I. (Ed.) (2020). Rozroblennia avtomatyzovanoho kompleksu dlia pretsyziynoho termoimpulsnoho obroblennia detonuvalnymy hazovymy sumishamy: naukovi materialy. Kharkiv: Nats. aerokosm. un-t im. M. Ye. Zhukovskoho «Kharkiv aviats. in-t», 318.
9. Gehrman, C., Gunnarsson, M. (2020). A Digital Twin Based Industrial Automation and Control System Security Architecture. *IEEE Transactions on Industrial Informatics*, 16 (1), 669–680. doi: <https://doi.org/10.1109/tii.2019.2938885>
10. Kong, K.-J., Jung, S.-H., Jeong, T.-Y., Koh, D.-K. (2019). 1D-3D coupling algorithm for unsteady gas flow analysis in pipe systems. *Journal of Mechanical Science and Technology*, 33 (9), 4521–4528. doi: <https://doi.org/10.1007/s12206-019-0848-2>
11. Sobieski, W., Grygo, D. (2020). Fluid flow in the impulse valve of a hydraulic ram. *Technical Sciences*, 3 (22). doi: <https://doi.org/10.31648/ts.4965>
12. Zhu, F., Liu, W., Li, X., Li, Z., Yan, T. (2022). Numerical simulation of gas-liquid two-phase flow on an attitude control system. *Journal of Physics: Conference Series*, 2276 (1), 012040. doi: <https://doi.org/10.1088/1742-6596/2276/1/012040>
13. Plankovskyy, S. I., Shypul, O. V., Zaklinskyy, S. A., Tryfonov, O. V. (2018). Dynamic method of gas mixtures creation for plasma technologies. *Problems of Atomic Science and Technology*, 118 (6), 189–193. Available at: [https://vant.kipt.kharkov.ua/ARTICLE/VANT\\_2018\\_6/article\\_2018\\_6\\_189.pdf](https://vant.kipt.kharkov.ua/ARTICLE/VANT_2018_6/article_2018_6_189.pdf)
14. Philipbar, B. M., Waters, J., Carrington, D. B. (2020). A finite element Menter Shear Stress turbulence transport model. *Numerical Heat Transfer, Part A: Applications*, 77 (12), 981–997. doi: <https://doi.org/10.1080/10407782.2020.1746155>
15. Raje, P., Sinha, K. (2021). Formulation of advanced SST turbulence model for shock-boundary layer interaction. *AIAA AVIATION 2021 FORUM*. doi: <https://doi.org/10.2514/6.2021-2841>
16. Ansys, Inc. (2020). ANSYS CFX-Solver Theory Guide Release 2020-R1. ANSYS, Inc., Canonsburg, PA, USA.