

Запропоновано методику узагальненого аналізу та оптимізації надкритичних циклів холодильних машин і теплових насосів, що дозволяє проводити спрямований пошук технологічних схем з урахуванням структурно-топологічних особливостей обладнання, яке входить в їх склад. З використанням графічного апарату С-кривих проведено узагальнений термoeкономічний та еколого-енергетичний аналіз різних по структурній складності схемних рішень холодильних установок

Ключові слова: деструкція ексергії, термoeкономічний аналіз, надкритичний цикл, С-криві

Предложена методика обобщенного анализа и оптимизации сверхкритических циклов холодильных машин и тепловых насосов, позволяющая проводить направленный поиск технологических схем с учетом структурно-топологических особенностей входящего в их состав оборудования. С использованием графического аппарата С-кривых проведен обобщенный термоэкономический и эколого-энергетический анализ различных по структурной сложности схемных решений холодильных установок

Ключевые слова: деструкция эксергии, термоэкономический анализ, сверхкритический цикл, С-кривые

UDC 621.577;621.564

DOI: 10.15587/1729-4061.2016.79988

APPLICATION OF GRAPHIC APPARATUS OF C-CURVES FOR THE ANALYSIS AND OPTIMIZATION OF SUPERCRITICAL CYCLES OF THERMOTRANSFORMERS

D. Kharlampidi

Doctor of Technical Sciences, Leading Senior Researcher*

E-mail: kharlampidi@ipmach.kharkov.ua

V. Tarasova

PhD, Senior Researcher*

E-mail: VAT1971@mail.ru

M. Kuznetsov

PhD, Researcher*

E-mail: childeric@rambler.ru

S. Omelichkin

Postgraduate Student*

E-mail: sergiomelichkin@gmail.com

*Department of modeling and identification of heat processes

A. N. Podgorny Institute problem in machinery of

National Academy of Sciences of Ukraine

Dm. Pozharsky str., 2/10, Kharkiv, Ukraine, 61046

1. Introduction

The interest in the use of natural refrigerants, among which carbon dioxide (R744) holds a special place, in refrigerating machines (RM) and heat pumps (HP) has grown significantly in recent years. This refrigerant has zero ozone depletion potential (ODP=0) and negligible global warming potential (GWP=1). Therefore, R744 is regarded by many experts as one of the main working fluids for heat pumps and self-contained air conditioners in the long run. Low critical temperature of carbon dioxide ($T_{cr}=31\text{ }^{\circ}\text{C}$, $P_{cr}=73.83\text{ bar}$) leads to application of a so-called supercritical cycle, which does not involve condensation, and convective cooling is used for heat removal. It should be noted that low efficiency [1] is characteristic of this cycle.

Meanwhile, the supercritical systems using R744 as a refrigerant have significant potential for optimization. This factor, combined with environmental benefits compensates energy loss as compared to subcritical systems and ultimately allows developing a very compact and fairly powerful system.

2. Literature review and problem statement

Today there is an urgent need for research aimed at optimization of supercritical cycles. This issue was raised by the

authors of [2], but consideration went without generalization of the results. Optimization was usually carried out for a specific flow diagram or one of its components using sophisticated mathematical tools, namely mathematical modeling of the refrigerant circuit. The results, despite the time-consuming process of modeling, were private and lacked generality and clarity.

In [3], a critical analysis of existing approaches to the discharge pressure optimization P_{dis}^{opt} in a single-stage supercritical cycle is presented. The impact of various operating parameters on the energy efficiency of the cycle is examined. However, the authors overlooked the issue of determining P_{dis}^{opt} for two-stage cycles.

The paper [4] deals with the discharge pressure optimization in the cycle as well. It examines both single-stage and two-stage flow diagrams of refrigerating machines, provides a comparative analysis of errors of finding P_{dis}^{opt} based on various correlation equations. Despite the fact that different cycles were considered, the authors confined themselves to a simple comparison of flow diagrams and equations for P_{dis}^{opt} . Meanwhile, an important issue of assessing the impact of the flow diagram complexity on the P_{dis}^{opt} variation in the cycle was neglected for several reasons. There are grounds to believe that the traditional practice of optimizing thermotransformers cycles, both subcritical and supercritical,

ignores the deterministic structural complexity of circuit designs. Furthermore, it is implemented without the adequate use of modern methods of applied thermodynamics such as thermoeconomics [5].

The first attempt to carry out an exergy-economic analysis of single-stage refrigerating machine operating in a supercritical cycle with the R744 refrigerant was made in [6]. The optimum discharge pressure and the cost of exergy destruction for each element were determined for different modes of the single-stage machine. Meanwhile, such an approach is useful for comparative analysis of various operating parameters of similar flow diagrams only.

The authors of [7] carried out thermoeconomic optimization of the cascade refrigerating machine based on the R744 refrigerant as a working fluid of the bottom cascade stage. In the upper cascade stage, ammonia NH_3 was a working fluid, and the refrigerating machine operated in a subcritical cycle. Despite the fact that this is one of the few works devoted to thermoeconomic optimization of RM with R744, recommendations shall not be used directly for both single-stage and two-stage supercritical cycles.

Optimization of the flow diagram shall be performed in conditions where there is a set of competing flow diagrams for achieving the same purpose. Given the diversity of HP or RM equipment, as well as a large number of possible structural connections of elements in the flow diagram, there is a problem of finding a rational structure of the RM flow diagram providing high efficiency under given conditions.

The solution of this problem is connected with the analysis and evaluation of various options of RM flow diagrams, both known and new, synthesized on their basis. This requires a single evaluation criterion of flow diagrams and equipment, free from the influence of subjective factors, such as the criterion of complexity [8].

The criterion of complexity is a qualitative characteristic for which there is virtually no single evaluation method at present. Evaluation of the complexity criterion of any technical system is based on primarily a characteristic of the structural complexity of the flow diagram, the complexity of its design, operation, etc.

A review of existing methods for evaluating the structural complexity of the flow diagram, carried out in [8], showed that the most versatile is the criterion of complexity of the following form:

$$D_{di} = D_i' (2\bar{m} + \bar{p}), \quad (1)$$

taking into account the total number of interactions of the thermotechnical system with the environment \bar{p} (in this case: heat removal from the condenser, low-grade heat supply to the evaporator, power supply to the steam compression), the total number of process linkages between the system elements \bar{m} and the total complexity of all elements D_i' .

Thus, the introduction of the flow diagram complexity criterion to the pre-design analysis will enable a systematic approach to the consideration of some issues related to the cycles optimization. The criterion of complexity will serve as a kind of “navigator” in the search for flow diagrams and construction of generalized characteristics of them, which ultimately will allow following the trend of improving their performance.

3. Research goal and objectives

The goal of the research is to develop a method of analysis and optimization of supercritical cycles, which takes into account the impact of structural and topological features of flow diagrams of thermotransformers on thermoeconomic and environmental indicators.

To achieve this goal, it is necessary to solve a number of problems, namely:

- to conduct a generalized thermoeconomic analysis of the RM supercritical cycles using a deterministic criterion of structural complexity;
- to propose a generalized algorithm for determining the optimum exergy-economic and environmental indicators of circuit designs using a graphic apparatus of C-curves.

4. Analysis and optimization of supercritical cycles of refrigerating machines

Let us consider a number of single-stage and two-stage flow diagrams of RM operating in a supercritical cycle (Fig. 1). The diagrams have different structural complexity and optimum discharge pressure in a cycle. The recommendations of the works [1, 3, 4, 8] were used to find the optimum discharge pressure in supercritical cycles.

Fig. 1 takes the following notations: CM – compressor; GC – gas cooler; THR – throttle; EXP – expander; EVP – evaporator; RHE – regenerative heat exchanger; SSC – superheated steam cooler; IC – intercooler; SEP – separator; EJ – ejector.

One of the conditions for a correct comparison of the diagrams was equality of temperature limits of a cycle for both single-stage and two-stage units. Fig. 2 shows the variation in the maximum coefficient of performance ϵ_{max} in a cycle, corresponding to the optimum discharge pressure, depending on the diagram complexity D_{di} . As can be seen from Fig. 2, complication of the diagram after a certain value of the D_{di} criterion does not give rise to further improvement of the energy performance of the unit. The maximum coefficient of performance ϵ_{max} reaches the limit when $D_{di}=20$ and does not grow for more complex diagrams.

Obviously, each additional flow diagram complication leads to increased capital cost of the unit. In this regard, a comprehensive analysis in the future will require involving technical and economic parameters of the designed system.

To justify the flow diagram complication, as well as to select from the available options of units of different complexity with minimum costs over the entire lifecycle, we use the graphic apparatus of C-curves. The idea of analysis by means of C-curves is described in [9]. At first, it has not found practical application and was used as supporting data in exergy analysis textbooks. Only with a broad introduction of thermoeconomic optimization techniques to the practice of designing energy conversion systems, graphical interpretation of the results has acquired more meaningful information value.

In terms of the mathematical apparatus, the analysis of C-curves is an addition to differential calculus of functions of one or several variables. It graphically shows the ratio of exergy expenditures and other optimization factors. In the thermoeconomic analysis, as is known, such factors are capital expenditures and operating costs of the unit.

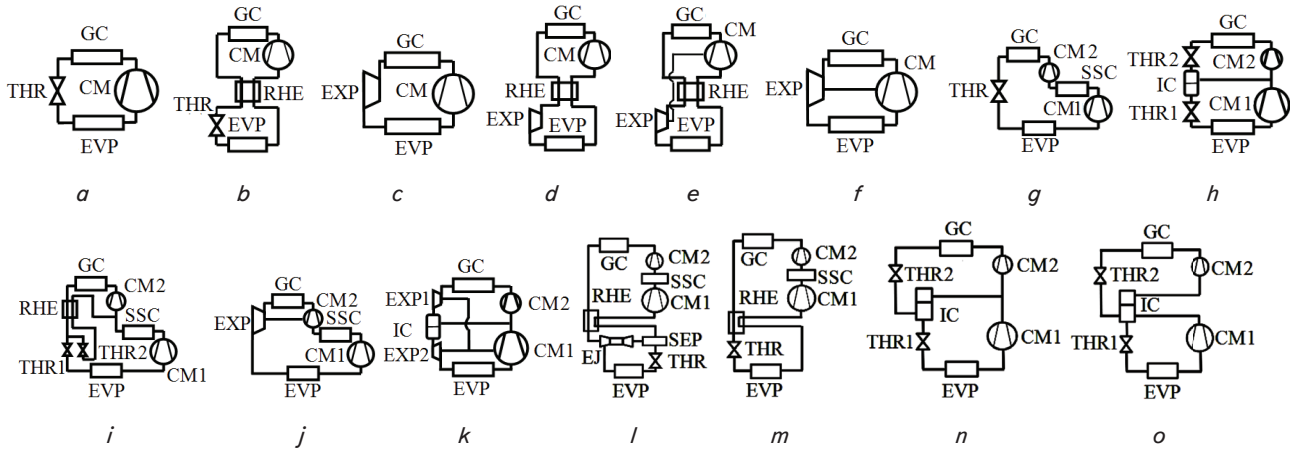

Fig. 1. The flow diagrams of supercritical RM with R744: *a* – simple single-stage ($D_{di}=11$); *b* – single-stage with regeneration ($D_{di}=15$); *c* – single-stage with an expander ($D_{di}=12$); *d* – regenerative with an expander ($D_{di}=16$); *e* – regenerative with a combined expander ($D_{di}=18$); *f* – simple single-stage with a combined expander ($D_{di}=14$); *g* – two-stage with incomplete intercooling ($D_{di}=17$); *h* – two-stage with intermediate steam injection ($D_{di}=20$); *i* – two-stage with incomplete cooling and double throttling ($D_{di}=25$); *j* – two-stage with a combined expander of the second stage ($D_{di}=20$); *k* – two-stage with intermediate steam injection and combined expanders with the first-stage compressor ($D_{di}=26$); *l* – two-stage cycle with an ejector, incomplete intercooling RHE and separator ($D_{di}=27$); *m* – two-stage cycle with incomplete intercooling and RHE ($D_{di}=21$); *n* – two-stage flow diagram with intermediate steam injection and double throttling ($D_{di}=20$); *o* – two-stage flow diagram with complete cooling in an intercooler and double throttling ($D_{di}=20$)

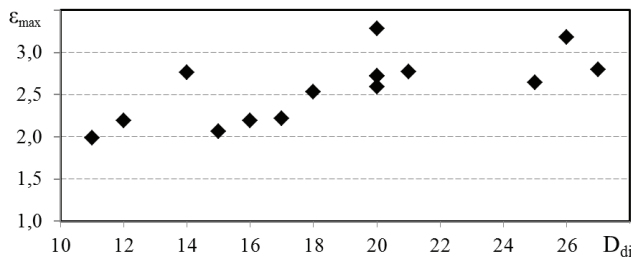

Fig. 2. The values of ϵ_{max} for the flow diagrams of RM with different complexity D_{di}

The amount of capital expenditures and operating costs is cash expenditures over the entire lifecycle of the unit:

$$\Xi = \frac{\tau_{op} c_e}{a_D} E_{di} + Z, \tag{2}$$

where Ξ – total cash expenditures over the lifecycle of the unit, E_{di} – unit input exergy, kW; Z – total capital cost of the unit, \$; τ_{op} – operation time of the unit for the year, h; a_D – replacement cost factor; c_e – specific cost of the primary incoming energy flow (compressor drive exergy) in the system, \$/(kW×h).

When recording (2), the model to describe economic factors, based on the replacement cost factor is used [8].

For the pre-design analysis of flow diagrams, the functions of the capital cost of equipment (Table 1), proposed in [10] are used. These are correlation equations, derived based on the statistical data processing. The source of data are catalogs of refrigeration equipment manufacturers.

Fig. 3 shows the dependence of capital expenditures Z_i of the basic equipment of the unit on the cooling capacity Q_0 . It can be seen that the dependencies are nonlinear that must be considered when choosing the flow diagram.

Table 1

The cost functions of the basic equipment of the unit

Basic equipment	Determining factor X	Cost function Z_i (\$)
Compressor (CM)	Shaft power (kW)	$9000 \cdot X^{0.6} + 20.00$
Turboexpander (TE)	Shaft power (kW)	$9000 \cdot X^{0.69} + 40.00$
Gas cooler (GC)	Surface area (m ²)	$450 \cdot X^{0.82} + 5000$
Evaporator (EVP)	Surface area (m ²)	$900 \cdot X^{0.82} + 10.00$

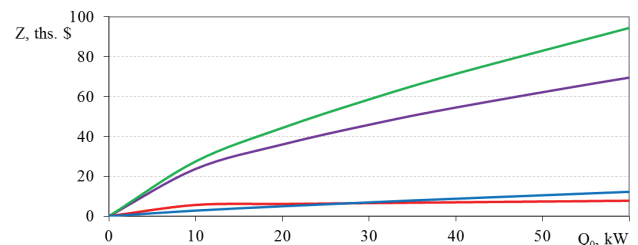

Fig. 3. The dependence of Z_i on Q_0 :

— CM; — TE; — GC; — EVP

It should be noted that with the same given cooling capacity, for the flow diagrams of different complexity, the value of the total exergy destruction in the unit E_D can be used instead of E_{in} in (1), which, as is known, indicates the exergy over-expenditure in a cycle compared to the drive power expenditure in an ideal Carnot cycle N_{Carnot} :

$$E_{in} = N_{Carnot} + E_D.$$

Since at constant temperature limits of a cycle (evaporation temperature $T_0=0$ °C, the GC outlet temperature $T_3=40$ °C) N_{Carnot} for all considered flow diagrams is the same, the variation of total expenditures during the flow diagram complication can be written as

$$\Delta \Xi = \frac{\tau_{op} c_e}{a_D} \Delta E_D + \Delta Z.$$

When varying the parameter D_{di} , there is a variation of the capital (Fig. 4) and exergy expenditures (Fig. 5).

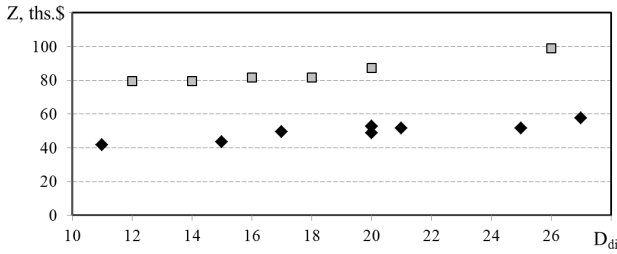

Fig. 4. The variation of the value of capital expenditures of the RM with cooling capacity $Q_0=16$ kW depending on the flow diagram complexity D_{di} : \blacklozenge – flow diagrams with a throttle; \square – flow diagrams with an expander

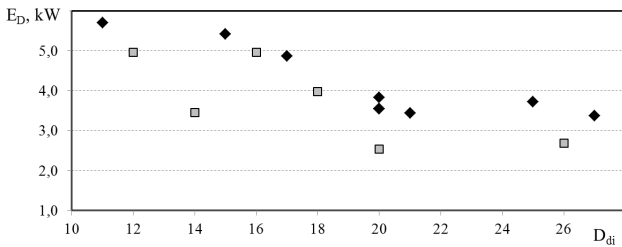

Fig. 5. The values of E_D depending on D_{di} for the RM with cooling capacity $Q_0=16$ kW \blacklozenge – flow diagrams with a throttle; \square – flow diagrams with an expander

As can be seen from Fig. 4, the presence of an expander in the flow diagram significantly increases the cost of the unit. The analysis of Fig. 5 showed that for the dependence $E_D=f(D_{di})$ only a single nature of variation in the total destruction for flow diagrams of different complexity can be clearly stated without singling out the expander and throttle flow diagrams individually, as in the previous case.

Further, for convenience, dictated by the use of the equation (2), instead of Z we use the value of capital expenditures, reduced to the operating time of the unit for a year $z'=Z/\tau_{op}$, measured in $\$/h$.

Excluding the variable parameter D_{di} from consideration, the graph $E_D=f(z')$ is plotted (Fig. 6), which has a minimum of reduced cash expenditures at the highest exergy destruction and a minimum of the drive exergy expenditures, but through the cash over-expenditure. The segment of the C-curve connecting the points corresponding to the minimum values of z' and E_D is called an arc of choice. Each point on the arc of choice corresponds to a compromise between the economic and exergy indicators of the system. The parts of the C-curve located above the E_{Dmin} point or to the right of the z'_{min} point show the overrun of exergy and capital expenditures, so they are not considered in the further analysis. The coordinated optimum can be found by assuming a linear relationship between the exergy over-expenditures ΔE_D and costs $\Delta z'$

$$\Delta z' = \text{tg}\alpha \Delta E_D, \tag{3}$$

where, according to (2), the slope is equal to

$$\text{tg}\alpha = \frac{c_e}{a_D}. \tag{4}$$

In [9], the slope ($\text{tg}\alpha$) was taken equal to the cost of reference fuel in the world market. In this case, the choice of the flow diagram depends greatly on the cost of fuel, which acts as a major variable factor in the optimization. The systems operating in a supercritical cycle are characterized by high capital costs of the unit. Therefore, the cost of the fuel consumed will always be incommensurably smaller value. This leads to the fact that the choice will be made only in favor of cheaper units during optimization. The choice of more sophisticated flow diagrams requires a significant increase in the cost of fuel that does not meet the estimated variations in the cost, even in the long term.

In contrast to [9], this study used the method of calculating the total expenditures over the entire lifecycle of the unit, in which the contribution of the capital component to the target product cost (cold) is determined at the rate of return of bank investments to the project. Thus, the contribution of the capital component to the target product cost for a year is offset, which in general shall contribute to a more intensive introduction of expensive energy-saving technologies. The investment component in the cost of a product is determined considering that the loan with a bank interest was returned to the bank for the life of the unit [8].

This approach allowed varying not the cost of fuel during optimization, but the operation period of the unit (years). The optimum in this case will correspond to the minimum total cost over the entire lifecycle according to current electric power tariffs and taking into account investments.

Fig. 6 shows the possible options of constructing the C-curves. Here, numerals indicate the values of the flow diagram complexity D_{di} . A common C-curve can be constructed by connecting the points 11, 15, 20 (flow diagram with THR) 21, 20 (flow diagram with EXP) and 26. In this case, the majority of the flow diagrams do not lie on the C-curve, namely the flow diagrams with the complexity of 17, 25, 12, 16, 18 and 14. Therefore, several C-curves shall be singled out in order not to exclude most flow diagrams from consideration.

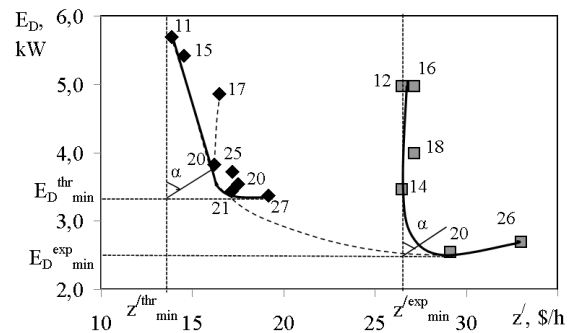

Fig. 6. The C-curves for flow diagrams of different complexity in the exergy – economy coordinate system: \blacklozenge – flow diagrams with a throttle; \square – flow diagrams with an expander

As shown in Fig. 6, there are two clear C-curves corresponding to the flow diagrams with the throttle valve with the complexity of 11, 15, 20, 21, 27 and flow diagrams with the turbo expander ($D_{di}=12; 14; 20; 26$). Each curve has the minimum values of capital costs and exergy destruction, which ultimately determine the arc of choice. The flow diagrams with THR having complexity $D_{di}=16$ and $D_{di}=26$

lie beyond the arc of choice. By drawing a straight line at an angle $\alpha=54^\circ$ to the C-curve vertical for throttle flow diagrams drawn from the point with coordinates $(z^{\text{thr}}_{\text{min}}; E_D^{\text{thr}}_{\text{min}})$, we obtain the coordinated optimum on the arc of choice corresponding to the flow diagram with complexity $D_{\text{di}}=20$. The angle α is determined for the case of the unit operation time of 20 years and the cost of electric power $c_e=0.07 \text{ \$/kW}\cdot\text{h}$.

The straight line drawn to the C-curve vertical for flow diagrams with an expander at the same angle α intersects the arc of choice at a point that does not correspond to any of the considered flow diagrams. In this case, the choice of the flow diagram is up to the designer: which of the options, adjacent to the intersection point, to choose as the final decision, the flow diagram with $D_{\text{di}}=14$ or $D_{\text{di}}=20$?

C-curves for single-stage and two-stage flow diagrams can be singled out in the same way. For example, for two-stage flow diagrams with THR, the C-curve is represented in Fig. 6 by the dashed line connecting the flow diagrams with the complexity of 17, 25, 20, 27. In this case, the flow diagram with complexity $D_{\text{di}}=17$ will not be included in the arc of choice.

It should be noted that, unlike the thermodynamics, in the economy, there is no concept of a universal model (sort of ideal cycle), applicable for describing economic factors. Therefore, the choice of an economic model is to a certain extent subjective and dictated by the current economic situation faced by the object in question. In addition, there are various approaches to the description of the capital cost of the RM elements by certain functions. So in absolute terms, the form of the dependencies obtained for the capital cost may be slightly different in case of another description model. However, the general methodological approach to the construction of C-curves remains unchanged.

A C-curve may be constructed not only on the basis of economic factors but also with regard to the environmental indicators of the RM impact on the environment.

For environmental and energy assessment of refrigerants in the corresponding system, the so-called total equivalent warming impact factor TEWI_N is widely used [11]:

$$\text{TEWI}_N = \text{GWP}_{\text{rf}}L_{\text{rf}}n + \text{GWP}_{\text{rf}}m_{\text{rf}}(1-\alpha) + \beta N_{\text{complete}}n, \quad (5)$$

where GWP_{rf} – the global warming potential relative to CO_2 ($\text{GWP}_{\text{CO}_2}=1$), $\text{kg CO}_2/\text{kg}$; L_{rf} – refrigerant leakage, kg/year ; n – the operation time of equipment, year; m_{rf} – the mass of refrigerant in the unit, kg ; α – the fraction of the refrigerant utilized after the end of operation; β – the amount of CO_2 released into the atmosphere (emission) in the production of 1 $\text{kW}\cdot\text{h}$ of electric power, $\text{kg CO}_2/(\text{kW}\cdot\text{h})$; N_{complete} – annual electric power expenditure on the operation of the equipment, $(\text{kW}\cdot\text{h})$.

In (5), the value L_{rf} is taken equal to 10 % of the mass of refrigerant in the unit, the CO_2 emission β directly depends on the region and the method of electric power production in this region. In the electric power production by burning oil and coal, β is about $0.8 \text{ kg CO}_2/(\text{kW}\cdot\text{h})$.

It should be noted that the first and second terms, considering the direct refrigerant emission depend on the mass of refrigerant, which in turn increases with the flow diagram complication. The thermodynamic efficiency of the unit affects the third term of the equation (5).

By analogy with (3), the coordinated optimum for the environmental indicator is about $\Delta\text{TEWI}_N = 0$ as

$$\Delta\text{eco}' = \text{tg}\gamma \cdot \Delta E_D, \quad (6)$$

where from (5)

$$\text{eco}' = \frac{[\text{GWP}_{\text{rf}}L_{\text{rf}}N + \text{GWP}_{\text{rf}}m_{\text{rf}}(1-\alpha)]}{\tau_{\text{op}}}$$

and $\text{tg}\gamma = \beta \cdot n$.

Fig. 7 shows the dependence $E_D=f(\text{eco}')$ for supercritical RM with R744.

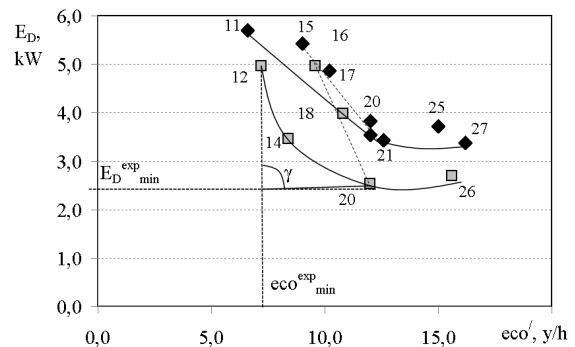

Fig. 7. The C-curve for units of different complexity in the of exergy – exergy coordinate system: ◆ – flow diagrams with a throttle; ◻ – flow diagrams with an expander

Fig. 7 shows that, as in case of construction of C-curves in the exergy – economy coordinates, there is also a number of possible options for constructing the C-curves, dividing the flow diagrams into units with an expander (12-14-20-26) or a throttle (11-20-21-27), as well as single-stage or two-stage (dashed lines). In Fig. 7, a straight line is drawn at an angle $\gamma=86.5^\circ$ to a vertical from the point with coordinates $(\text{eco}'^{\text{exp}}_{\text{min}}; E_D^{\text{exp}}_{\text{min}})$. The coordinated optimum is located at the intersection of this line with the arc of choice (12-14-20) and corresponds to the flow diagram with an expander $D_{\text{di}}=20$. This solution was found for the unit operation time ($Q_0=16 \text{ kW}$) of 20 years with $b=0.8 \text{ kg CO}_2/(\text{kW}\cdot\text{h})$. Note that, as in Fig. 6, the flow diagram with complexity $D_{\text{di}}=26$ is not included in the arc of choice.

The optimum flow diagram selected according to economic indicators will not always correspond to its environmental and energy assessment. In this case, the choice shall be done by the designer, taking into account both economic and environmental factors. As previously noted, it was necessary to choose one of the two flow diagrams with an expander with complexity $D_{\text{di}}=14$ and $D_{\text{di}}=20$ (Fig. 6). When determining the minimum value of the equivalent warming impact factor (Fig. 7) for these flow diagrams for the same operation time of RM, it becomes clear that a choice shall be made in favor of the flow diagram with $D_{\text{di}}=20$.

5. Discussion of the results of the analysis and optimization of supercritical cycles of refrigerating machines

Thus, we can conclude that the method of the generalized analysis and optimization of supercritical cycles, allowing to solve the problem of directed search of the most rational flow diagrams at the stage of pre-design development of refrigeration and heat pump systems, taking into account the structural and topological features of their equipment was proposed.

The proposed method is, in fact, unique because it is based on a synthesis of modern methods of thermodynamics, system engineering, and graphic optimization techniques. In particular, the graphic apparatus of C-curves was applied to determine the minimum cost of the design and operation of the system over the entire lifecycle. The main advantage of the method consists in the visual presentation of the results, that greatly facilitates the flow diagram selection process in the design of the refrigeration system, making it formalized and controlled.

One of the main benefits of the method is the use of the replacement cost factor for the economic analysis of competing flow diagrams. This allows using not the cost of reference fuel on the world market as the variable parameter in the optimization, but the estimated operation time of the unit. Such an approach shall promote the introduction of efficient expensive technologies of thermotransformation (e.g., complicated two-stage flow diagrams) in practice since in this case the contribution of the capital component is offset. However, there is a restriction for the use of the proposed method. It consists in the fact that the comparison is correct to carry out only among the flow diagrams with the same equipment. This is due to the fact that the complexity of the elements in (1) was assumed the same for all flow diagrams ($D_i=1$) when determining D_{di} . The introduction of D_i would substantially increase the dimensionality of the problem. In addition, the issue of calculating the value of complexity of the elements is debatable. To date, there is no common formalized approach to its definition.

In the future, the method with a few additions can be used in the analysis of cryogenic plants, as well as energy conversion systems operating in the direct Carnot cycle.

6. Conclusions

1. The thermoeconomic analysis using the criterion of complexity revealed a rational complication limit of RM flow diagrams. This limit is a technically feasible limit, when the introduction of additional equipment to the RM flow diagram structure in order to reduce the internal irreversibility in a cycle does not lead to the desired result, i. e., efficiency improvement.

2. As a result of thermoeconomic optimization using the graphic apparatus of C-curves, the two-stage flow diagram of RM with complete cooling in the intercooler and double throttling with complexity $D_{di}=20$ was chosen. This flow diagram has a minimum cost of the design and operation of the system over the lifecycle of 20 years with the lowest negative impact on the environment.

Acknowledgements

The work was supported by the State Fund for Fundamental Research of Ukraine within the framework of the contest project F66/12554 under the grant of the President of Ukraine.

References

1. Bratuta, E. G. Optimalnie usloviya realizatsii sverhkriticheskikh tsiklov holodilnykh mashin and teplovykh nasosov [Text] / E. G. Bratuta, A. V. Sherstuk, D. Kh. Kharlampidi // *Technicheskie gazi*. – 2011. – Vol. 6. – P. 9–14.
2. Sarkar, J. Simulation of a Transcritical CO₂ Heat pump Cycle for Simultaneous Cooling and Heating Applications [Text] / J. Sarkar, S. Bhattacharyya, M. Ram Gopal // *International Journal of Refrigeration*. – 2006. – Vol. 29, Issue 5. – P. 735–743. doi: 10.1016/j.ijrefrig.2005.12.006
3. Cecchinato, L. A critical approach to the determination of optimal heat pressure in transcritical systems [Text] / L. Cecchinato, M. Corradi, S. Minneto // *Applied Thermal Engineering*. – 2010. – Vol. 30, Issue 13. – P. 1812–1823. doi: 10.1016/j.applthermaleng.2010.04.015
4. Yang, L. Minimization COP loss from optimal high pressure correlation for transcritical CO₂ cycle [Text] / L. Yang, H. Li, S. W. Cai, Ch. L. Zhang // *Applied Thermal Engineering*. – 2015. – Vol. 89. – P. 656–662. doi: 10.1016/j.applthermaleng.2015.06.023
5. Tsatsaronis, Dzh. Vzaimodeystvie termodinamiki i ekonomiki dlya minimizatsii stoimosti energopreobrazuyushey sistemyi [Text] / Dzh. Tsatsaronis. – Odessa: Negotsiant, 2002. – 152 p.
6. Fazelpour, F. Exergoeconomic analysis of carbon dioxide transcritical refrigeration machines [Text] / F. Fazelpour, T. Morosuk // *International Journal of Refrigeration*. – 2013. – Vol. 38. – P. 128–139. doi: 10.1016/j.ijrefrig.2013.09.016
7. Rezayan, O. Thermoeconomic optimization and exergy analysis of CO₂ / NH₃ cascade refrigeration systems [Text] / O. Rezayan, A. Behbahaninia // *Energy*. – 2011. – Vol. 36, Issue 2. – P. 888–895. doi: 10.1016/j.energy.2010.12.022
8. Matsevytiy, Y. M. Systemno - strukturniy analis parocompressornih thermotransformatorov [Text] / Y. M. Matsevytiy, E. G. Bratuta, D. Kh. Kharlampidi, V. A. Tarasova. – Kharkiv: A. N. Podgorny Institute problem in machinery of NAS of Ukraine, 2014. – 269 p.
9. Yantovsky, Ye. I. Flows of energy and exergy [Text] / Ye. I. Yantovsky. – Moscow: Nauka, 1988. – 144 p.
10. Morandin, M. Thermoeconomic design optimization of a thermo-electric energy storage system based on transcritical CO₂ cycles [Text] / M. Morandin, M. Mercang z, J. Hemrle, F. Marechal, D. Favrat // *Energy*. – 2013. – Vol. 58. – P. 571–587. doi: 10.1016/j.energy.2013.05.038
11. Tarasova, V. O. Analiz ekologo-energetichnih characteristic suchasnihih chileriv i teplovihi nasosiv pri roboti z nepovnim navantazhennyam [Text] / V. O. Tarasova, D. Kh. Kharlampidi // *Energoberegenie. Energetika. Energoaudit*. – 2013. – Vol. 11, Issue 117. – P. 35–41.