

6. Дидык, Р. П. Эффект взрывного упрочнения металлов в зависимости от положения фронта детонации [Текст] / Р. П. Дидык. – Металлофизика и новейшие технологии. К., 1997. – С. 18–26.

#### References

1. Demchenko, L. D., Nadutov, V. M., Cherepova, Ju. S. (2003). Vliyanie predvaritel'noj plasticheskoj deformacii na strukturu i svojstva azotirovannyh sloev v Fe [Effect of preliminary plastic deformation on the structure and properties of nitrated layers in Fe]. OTTOM-4. Kiev, 205–209. [in Russian]

2. Didyk, R. P., Bezrukavaja, V. A., Grjaznova, L. V., Lisnjak, A. G. (2008). Vliyanie predvaritel'noj udarno-volnovoj obrabotki na parametry borirovaniya nizkolegirovannoj stali [Influence of pre-shock-wave treatment on the parameters of low-alloy steel Boriding]. Metallofizika i novejschie tehnologii [Metal Physics and Advanced Technology], 30 (9), 1289–1295. [in Russian]

3. Mejersa, M. A., Murra, L. E. (Eds.) (1984). Udarnye volny i javlenija vysokoskorostnoj deformacii metallov [Shock waves and the phenomenon of high-speed deformation of metals]. Moscow.: Metallurgija [Metallurgy], 512. [in Russian]

4. Jepshtejn, G. N., Kajbyshev, O. A. (1971). Vysokoskorostnaja deformacija i struktura metallov [High-speed deformation and structure of metal]. Moscow.: Metallurgija [Metallurgy], 196. [in Russian]

5. Stanjukovich, K. P. (1971). Neustanovivshiesja dvizhenija sploshnoj sredy [Unsteady motion of a continuum]. Moscow: Fizmat, 524. [in Russian]

6. Didyk, R. P. (1997). Jeffect vzryvnogo uprochnenija metallov v zavisimosti ot polozenija fronta detonacii [The effect of the explosive hardening of metals depending on the position of the detonation front] Metallofizika i novejschie tehnologii [Metal Physics and Advanced Technology]. Kiev, 18–26. [in Russian]

*Рекомендовано до публікації д-р техн. наук, професор Проців В. В.  
Дата надходження рукопису 30.03.2015*

**Козечко Виктория Анатольевна**, доцент, кандидат технических наук, кафедра технологии горного машиностроения, Государственное высшее учебное заведение «Национальный горный университет», пр. К. Маркса, 19, г. Днепропетровск, Украина, 49000  
E-mail: kozechko@list.ru

УДК:621.396

DOI: 10.15587/2313-8416.2015.40958

## USING ADAPTIVE ANTENNA ARRAY IN LTE WITH MIMO FOR SPACE-TIME PROCESSING

© Ali Abdourahmane Ahmed

*The actual methods of improvement the existent wireless transmission systems are proposed. Mathematical apparatus is considered and proved by models, graph of which are shown, using the adaptive array antenna in LTE with MIMO for space-time processing. The results show that improvements, which are joined with space-time processing, positively reflects on LTE cell size or on throughput*

**Keywords:** throughput, pattern, attenuator of signal, adaptation, LTE, MIMO

*Запропоновані фактичні методи удосконалення існуючих систем безпроводної передачі. Математичний апарат розглядається і доводиться моделями, графіками, що показані, використовуючи адаптивну антенну решітку в LTE з MIMO для просторово-часової обробки. Результати показують, що поліпшення, які пов'язані з просторово-часовою обробкою, позитивно відбиваються на розмірі ячеї LTE або на продуктивності*

**Ключові слова:** пропускна здатність, шаблон, атенюатор сигналу, адаптація, LTE, MIMO

### 1. Introduction

This work describes the problems of wireless transmission process in LTE system and gives effective way to overcome these problems and improve the existent transmission criterions by innovative method. This method lies in a using special kind of antennas which calls phased antenna array. Using this kind of antennas is not new for telecommunication sector but modern LTE system is not use it, probably because lack of observation. This thesis makes an accent on usefulness for LTE this mechanism and adaptation of antenna array algorithm. Phased arrays makes available to detect and attenuate the different irrelevant influences in a case when a priori information about noise environment is absent. In LTE the problem of lack of SNR (Signal – to – Noise

Ratio) is still actual for an expanding the cell area or increasing throughput. With the SNR values less than 10...15 dB the probability of receiving error increases and the throughput is decrease. The widely used methods of coding gives possible to increase the energetic of radio line u to 3 dB. But usually it is not enough, in this situation, one of the solution of this task could be using of phased. Analyzes of the operation of MIMO technology to LTE physical layer shown that for efficient operation of the communication system requires a channel with a sufficiently high value of signal/noise ratio  $h^2$  of about 20 dB or more, which in practice is not always attainable, especially when plural character of interarction of radiating elements (nalichin multiple interference). For values  $h^2$  less than 10 ... 15 dB increases dramatically the prob-

ability of erroneous reception and reduced bandwidth. Commonly used methods for encoding and decoding can improve power radio link to 3 dB. However, this is often not the case of multiple interfering nature of the impacts. Thus, the development of modified MIMO adaptive regarding SPO space-time signal processing is very timely.

## 2. Literature review

Broadband wireless access technologies, offering bit rates of tens of megabits per second or more to residential and business subscribers, are attractive and economical alternatives to broadband wired access technologies. Air interface standards for such broadband wireless metropolitan area network (MAN) systems in licensed and unlicensed bands below 11 GHz are being developed by the IEEE 802.16 working group and also by the European Telecommunications Standards Institute (ETSI), Broadband Radio Access Network (BRAN), High-Performance MAN (HiperMAN) group. Such systems, installed with minimal labor costs, may operate over non-line-of-sight (NLOS) links, serving residential and small office/home office (SOHO) subscribers. In such environments multipath can be severe. This raises the question of what types of anti-multipath measures are necessary, and consistent with low-cost solutions. Several variations of orthogonal frequency-division multiplexing (OFDM) have been proposed as effective anti-multipath techniques, primarily because of the favorable trade-off they offer between performance in severe multipath and signal processing complexity [1]. This article discusses an alternative approach based on more traditional single-carrier (SC) modulation methods. We show that when combined with frequency domain equalization (FDE), this SC approach delivers performance similar to OFDM, with essentially the same overall complexity. In addition, SC modulation uses a single carrier, instead of the many typically used in OFDM, so the peak-to-average transmitted power ratio for SC-modulated signals is smaller. This, in turn, means that the power amplifier of an SC transmitter requires a smaller linear range to support a given average power (in other words, requires less peak power backoff). As such, this enables the use of cheaper power amplifier than a comparable OFDM system; and this is a benefit of some importance, since the power amplifier can be one of the more costly components in a consumer broadband wireless transceiver.

## 3. Methods of adaptive spatio-temporal processing in LTE

One of the promising methods for improving noise immunity systems of LTE is the space-time signal processing [2, 3]. Under space-time signal processing generally understand some set of operations on the signals received at different points in space, which allows to extract the maximum value contained in them useful information. Algorithms of the space-time signal processing subdivided into structural and non-structural [4, 5]. For non-structural characteristic of algorithms there are: sensitivity to changes in signal-jamming environment (SJE), specialization for particular types of signals, the need for a priori information about the signal, interference and noise [6].

Usage of structural methods led to the creation of adaptive antenna arrays and adaptive interference canceler SJE. In this case, the task of deciding on the information parameters in the algorithms and SJE does not provide. Their main goal is improvement of the SJE [7]. This goal is achieved in that the operation of the adaptive antenna arrays adaptively depending on the SJE formed such amplitude and phase of the current distribution and, hence, such a radiation pattern, in which the interference fall to zero in this diagram [8, 9]. In other words the functioning of the algorithm is to find vector weighting coefficients, which would provide a minimum of errors, a minimum of interference, the maximum SINR or some other quality criteria chosen, whereby the functioning and control algorithm. Control algorithms and SJE does not require a priori information of large amount. They tend to be stable in the face of change and open source software is versatile enough, i. e., useful for the treatment of a broad class of signals, and it is extremely important not require a priori information about the noise parameters. In this case, the algorithms allow SJE and suppress noise by 20–40 dB [10, 11]. Naturally, the further improvement of performance quality in connection with the LTE network MIMO is impossible without extensive use of systems of adaptive spatio-temporal processing. This provides a significant increase in bandwidth or reducing the probability of errors of radio exchange data without slowing down the transmission in multiple multipath signals. Using MIMO as adaptive adaptive antenna arrays also provide coverage extension and smoothing them in dead zones, increasing the capacity of communication channels due to the formation of signal processing systems using space-time, frequency and polarization division multiplexing, as well as the direction of arrival of superresolution signal to the receiver.

As shown above, the choice of adaptation of the LTE MIMO to the changing characteristics of the wireless channel depends on the presence or absence of line of sight. The problem is solved differently depending on this adaptation. In the presence of line of sight increases sharply correlation signals in MIMO channels. In this case it is convenient organization for the other party by a narrow beam, formed in accordance with the application. As the beam-forming algorithms narrow beams can be used software methods and algorithms of adaptive antenna arrays synthesized for non-stationary signal and noise conditions [12]. Therefore, the two main methods of formation of narrow beams are physical and mathematical beamforming, where the first method is physically dependent on changing the direction of transmission and reception, and the second component selects the best channel mathematically, which is considered a more appropriate choice for LTE and MIMO base stations because of the lower complexity of its implementation.

## 4. Features of realization of single-mode algorithm of adaptive space-time processing

Equation (15) allows finding the best coefficient vector AR. However, to really use it is necessary to know the correlation matrix of noise – in fact know the location of interference. In practice, as a rule, possible

interference is not known beforehand. Therefore, interest algorithms [5], which can without a priori information to adjust the vector of coefficients of the AR to this optimal solution.

The idea is to turn-tuning vector

$$\vec{W}_i(L+1) = \vec{W}_i(L) + f(\vec{W}(L), \vec{S}(L), \vec{U}(L)), \quad (1)$$

where  $L$  – iteration number in time.

In this case, on the basis of information about the significance of the signal, interference and the current coefficient vector is the following approximation of the coefficient vector in the direction of AR optimal solutions according to the Wiener-Hopf equation.

To solve this problem, it is used the method of minimum mean square error.

Let the input signal is present known useful

$$S_i(L) = (1 + \sin(0.05L)) e^{j2\pi \frac{d(i-1)\sin\theta_0}{\lambda}}, \quad (2)$$

where  $i$  – item number AP, a  $L$  – reference number of the signal in time.

We assume that in addition to the signal at the input of AP elements is present interference with the noise

$$U_i(L) = U_i(L) + \sum_{m=1}^{M_{ii}} U_m(L) e^{j2\pi \frac{d \sin\theta_{m(i-1)}}{\lambda}}. \quad (3)$$

where  $U_i(L)$  – Gaussian random complex number representing the value of the noise in the  $L$  – point in the  $i$ -m element AP. Noise values at different times and in different cells AP (including one time point) are statistically independent and therefore noise modeling may be used Gaussian random number generator.

Similarly, the interference from various sources can also be considered to be statistically independent, but their variation in time is unknown. Therefore  $\dot{U}_m(L)$  can also be reproduced using Gaussian random numbers. On Fig. 1 shows a block diagram of a device that implements the algorithm to minimize the mean square error. In a known received signal  $S(L)$  and the signal value at the output of AP in the  $L$ -th point in time  $Z(L)$ , the magnitude of the error is  $e(L)$ . An algorithm for minimizing the mean squared error is in the change AP coefficients so that the error tends to 0 in the case where the error is 0, the effect of noise on the output available.

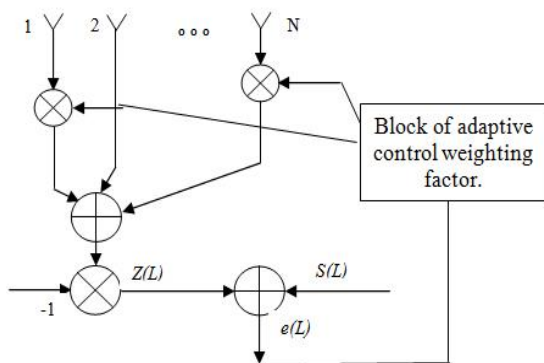

Fig. 1. Block diagram of the device of the algorithm to minimize the mean square error

$$\left. \begin{aligned} e(L) &= S(L) - \vec{W}(L)^T \{ \vec{S}(L) + \vec{U}(L) \}; \\ \vec{W}(L+1) &= \vec{W}(L) + 2\mu e(L) \{ \vec{S}(L) + \vec{U}(L) \}^* \end{aligned} \right\} \quad (4)$$

This algorithm is a sufficient number of iterations is reduced to the solution of the Wiener-Hopf, where \* – complex conjugation. Consider the question of the choice of the coefficient  $\mu$ . This ratio determines the speed of convergence (adaptation) algorithm and its stability and may range [5]

$$\frac{1}{\sum_{i=1}^N D_i} > \mu > 0, \quad (5)$$

where  $D_i$  – The variance of the input process (including all interference, signal and noise) in the  $i$ -m element of the AR. A too large value of this coefficient algorithm is unstable. If you select a factor too small, then the algorithm will converge very slowly. In practice, the value of the coefficient is given approximately 10 times less than the maximum allowable value. Given that the level of interference with zero direction is much higher than the level of signal and noise for a coefficient  $\mu$  simplified oredelyaetsya inequality

$$\frac{1}{ND_1} > \mu. \quad (6)$$

In minimum mean square error algorithm to produce an error signal in the adaptive processor must be expected signal. In practice, this information is not available, otherwise would not have needed an adaptive processor. In real systems, which implement a minimum mean square error algorithm, as estimated useful signal is artificially inserted fully known pilot signal. Pilot signal should have similar characteristics to the expected useful signal. In this case, the adaptive array generates a radiation pattern in the direction specified by the parameters of the pilot signal. In described two algorithms for adaptation of the pilot signal – single-mode and dual-mode. In LTE, provided an opportunity to implement a dual-mode algorithm, in which the adaptation takes place alternately – it really takes to process the input from the AP elements, then the pilot signal. In the adaptation process to the real input reference signal is missing – and the system tries to suppress all incoming signals and noise. In the pilot it is formed the main lobe of the NAM. The drawback of the algorithm is that the adaptation mode according to the pilot signal of the system suppresses all signals including useful. Deprived of the lack of single-mode algorithm.

In this case, the adaptive processor for subsidiary usage for incremental search AP coefficients and for generating an output signal used AP-core processor. Vector of coefficients for the main processor is a copy of the coefficient vector of the adaptive algorithm. Using such algorithm, preferably as adaptation block divided from the wanted signal reception unit which uses weighting coefficients adaptation unit. AAP useful signal with this construction scheme is not suppressed.

**5. The results of simulation of broadband communication system with MIMO and using single-mode adaptation algorithm for the pilot signal**

In currently, in LTE systems mostly used well tested in broadband radio systems vibrator arrays with different numbers of vertical linear systems vibrators (Fig. 2). Such lattices are currently working in the schemes without NAM adaptation to the user terminal. In the horizontal plane, each column has a circular radiation pattern.



Fig. 2. Dipole antenna arrays with different numbers of vertical linear systems vibrators

We investigate the effect of the coefficient  $\mu$  and variance  $D1$  interference on the convergence of the algorithm. For this we use a mathematical model that discussed above adaptation algorithm. The results of modeling in MatLab are shown in Fig. 4–14. Text to program of convergence analysis of the adaptation process is presented in Appendix B.

Results of the study according to the convergence of the algorithm to adapt to the number of steps to adapt for different values of the noise variance and the parameter  $\mu$  are shown in Fig. 4–8, and graphic patterns after adaptation – by Fig. 9–14.

The simulation results show that the algorithm works well for large values of the noise variance, i. e., with strong interference. By reducing the interference power algorithm loses the ability to distinguish the dominant interference by the general noise level. It is seen that adaptation deteriorates with a decrease of noise immunity in the variance  $D$ . When  $D1 < 1$  adaptation actually breaks. Normalized Power AP from omnidirectional radiators is  $N$  [aaaaa]. In our case  $P_{sig}$  rules=5. The standard deviation – the normalized interference power varies  $\sqrt{D}$  from 3.16 to 0,45.

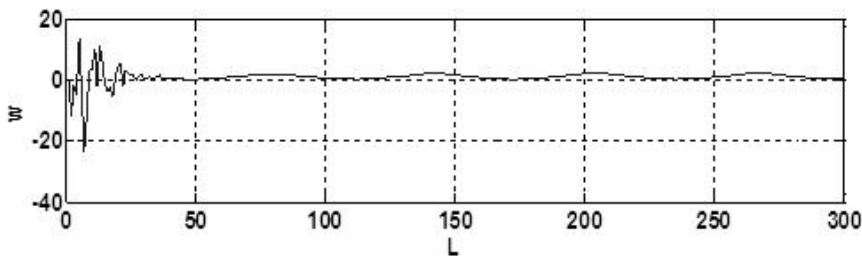

Fig. 4. Implementation of the convergence of the algorithm functions on the number of steps to adapt

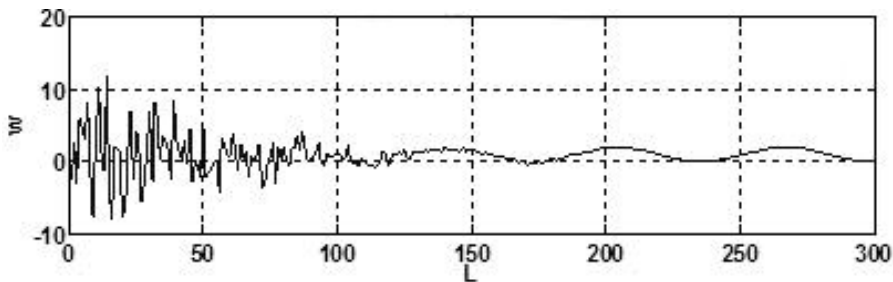

Fig. 5. Implementation of the convergence of the algorithm functions on the number of steps to adapt

Reduce the coefficient adaptation  $\mu$  accompanied by increased stability of the adaptation algorithm, (Fig.10, 11). Decrease of the same variance of the noise

is accompanied by a decrease in the stability of the adaptation algorithm (Fig. 12), which is not inconsistent with conclusions of the theory of adaptive antenna systems

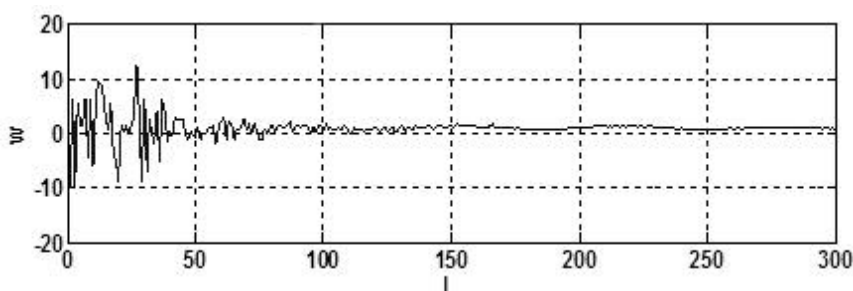

Fig. 6. Implementation of the convergence of the algorithm functions on the number of steps to adapt

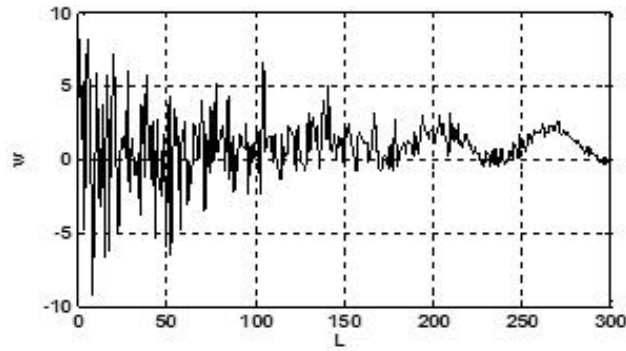

Fig. 7. Implementation of the convergence of the algorithm functions on the number of steps to adapt

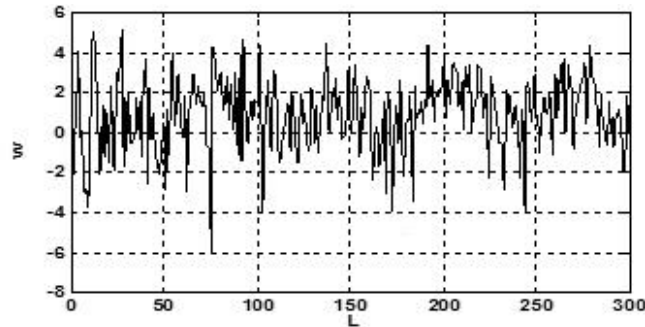

Fig. 8. Implementation of the convergence of the algorithm functions on the number of steps to adapt

Changing the NAM in the process of adaptation at  $D1=10$ ,  $N=5$  and different directions for interference example illustrates the graphs in Fig. 13–18. For the angle of arrival of the pilot signal wondered angles  $\theta_{SIG} = 45^\circ$  interference from  $-60^\circ$  to  $80^\circ$ . Simulation showed that the AP adapts pilot signal interference is rejected and receives signals with a maximum of NAM in the direction of arrival of desired signals. It was observed that during the approach angles useful signal and noise adaptation gives an error in the angle of the desired signal (Fig. 13, 15). Error increases with decreasing angle difference.

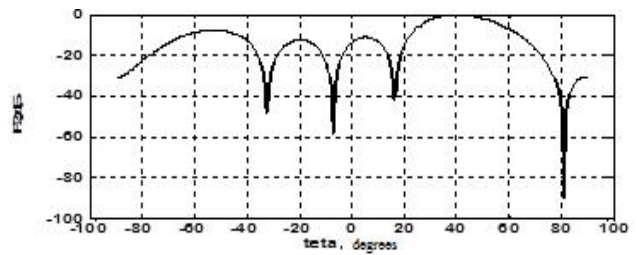

Fig. 11. Diagram of AP after adaptation  $\theta_{SIG} = 45^\circ$ ,  $\theta_{JAM} = 80^\circ$

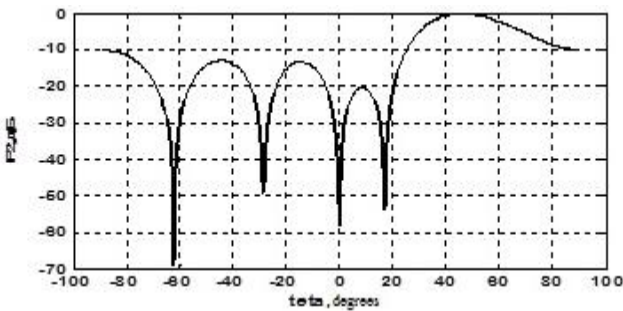

Fig. 9. Diagram of AP after adaptation  $\theta_{SIG} = 45^\circ$ ,  $\theta_{JAM} = 0^\circ$

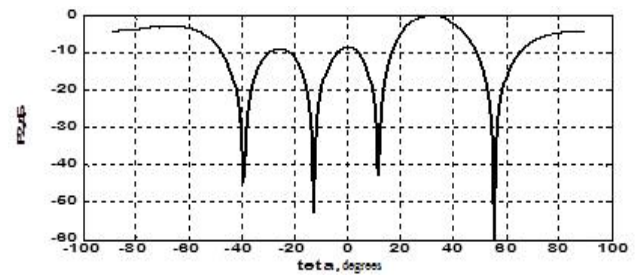

Fig. 12. Diagram of AP after adaptation  $\theta_{SIG} = 35^\circ$ ,  $\theta_{JAM} = 55^\circ$

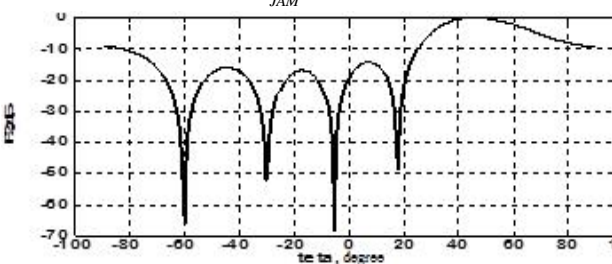

Fig. 10. Diagram of AP after adaptation  $\theta_{SIG} = 45^\circ$ ,  $\theta_{JAM} = -60^\circ$

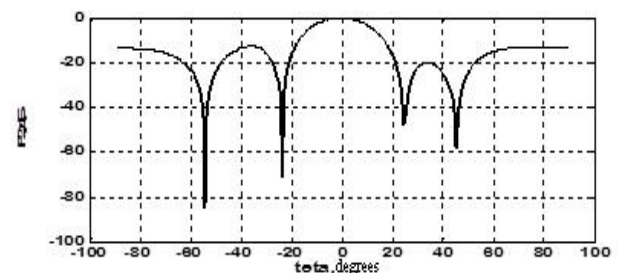

Fig. 13. Diagram of AP after adaptation  $\theta_{SIG} = 0^\circ$ ,  $\theta_{JAM} = 45^\circ$

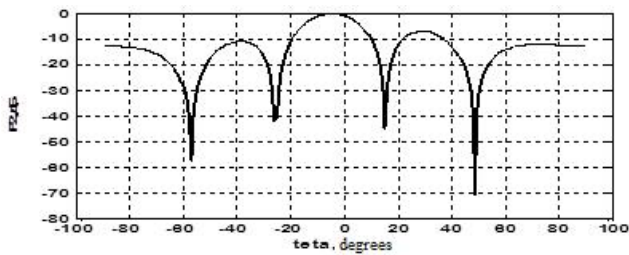

Fig. 14. Diagram of AP after adaptation  $\theta_{SIG} = 5^\circ$ ,  
 $\theta_{JAM} = 15^\circ$

The obtained results confirm the efficiency algorithm. It is established that the main lobe NAM expanded compared to the case without adaptation. This entails a reduction in the level of the received signal and the possibility of contact noise in the main lobe. There are several ways to address this shortcoming.

The first way is an increase in the size of the AR, which is not always acceptable in practice. The second way is to replace the non-directional emitters aimed. As directional elements within range of communication systems can be used dipoles Fig. 2 or the director of a simple log-periodic antenna. When installed vertically, such AP (Fig. 2 and Fig. 3) has a significant narrowing of the radiation pattern in the vertical plane.

## 6. Conclusion

Novelty. This method is not used in current LTE transmission system but was prove that it gives benefit in 10-15 dB in according with existent systems and that's why it is very perspective.

Scientific and practice results. The considered description gives possibility to deploy antenna arrays in LTE base stations in a place where it can have the best relation "price-quality". There are many possibilities and details of spatial diversity which are still out this work. It's a food for thought about next project and about getting new, more effective transmission algorithm. It could be realized to some existent wireless systems or for a next generation.

1. Currently on the market there were specially designed for the LTE active-passive antenna systems. The passive part replaces existing operators of antenna systems of previous generations, and allows you to use 2G and 3G infrastructure, and active can meet the challenges of adaptive space-time processing significantly improves the signal/noise+noise and provides a solution to problems of 4G infrastructure. With the use of these modules may be implemented a three-sector adaptive antenna arrays to base stations LTE.

2. The possibility of using adaptive antenna arrays with single-mode adaptation algorithm for the pilot signals in LTE. Adaption factor should be chosen small enough ( $\mu \approx 0,1$ ) to ensure stable operation of the adaptation algorithm.

3. Simulation confirmed the high efficiency in LTE systems adaptive array antenna c singlemode adaptation algorithm for the pilot signal. Confirmation of possibility of forming a maximum NAM towards the desired signal and adaptive direction selection on interference for its rejection. This algorithm is especially

effective with strong interference, when the level is close to the level of the desired signal.

## References

1. Cimini, L. Analysis and Simulation of a Digital Mobile Channel Using Orthogonal Frequency Division Multiplexing [Text] / L. Cimini // IEEE Transactions on Communications. – 1985. – Vol. 33, Issue 7. – P. 665–675. doi: 10.1109/tcom.1985.1096357
2. Lee, J. MIMO Technologies in 3GPP LTE and LTE-Advanced [Text] / J. Lee, J.-K. Han, J. Zhang // EURASIP Journal on Wireless Communication and Networking, 2009.
3. Bondarev, V. N. Digital Signal Processing: Methods and tools [Text] / V. N. Bondarev, G. Tröster, V. S. Chernega. – Sevastopol: SevGTU, 1999. – 398 p.
4. Marchuk, L. A. Spatio-temporal signal processing for radio communication lines [Text] / L. A. Marchuk. – Lviv: YOU, 1991. – 136 p.
5. Popovski, A. P. Statistical theory of polarization-time signal processing in communication lines [Text] / A. P. Popovski. – Moscow: Radio and Communications, 1984. – 272 p.
6. Kharlanov, A. V. Building adaptive spatial-polarization radar system to protect against active noise interference with arbitrary spatial structure [Text] / A. V. Kharlanov // System obrobki informatsii. – 2010. – Vol. 2, Issue 83. – P. 182–187.
7. Balanis, C. A. Introduction to Smart Antennas [Text] / C. A. Balanis, P. I. Ioannides. – Morgan & Claypool Publishers, 2007. – 184 p.
8. Digital signal and image processing applications in radio-physical [Text] / Under red.V.F. Kravchenko. – Moscow: FIZMATLIT, 2007. – 544 p.
9. Popovski, V. V. Problems and methods of use of adaptive interference canceller [Text] / V. V. Popovski, U. U. Kolyadenko // Problems of intellectual and military transport. – 2003. – Vol. 4. – P. 294–302.
10. Zhuravlev, A. K. Signal processing in adaptive antenna arrays [Text] / A. K. Zhuravlev, A. P. Lukoshkin, S. S. Poddubnyi. – Lviv: Publishing House of Leningrad University, 1983. – 240 p.
11. Volosyuk, V. K. Statistical theory of radio systems and radar remote sensing [Text] / V. K. Volosyuk, V. F. Kravchenko; V. F. Kravchenko (Ed.). – Moscow: FIZMATLIT, 2008. – 704 p.
12. Stefania, S. LTE – The UMTS Long Term Evolution: From Theory to Practice [Text] / S. Stefania, T. Issam, B. Matthew. – John Wiley and Sons Second Edition, 2011. – P. 217–222.

## References

1. Cimini, L. (1985). Analysis and Simulation of a Digital Mobile Channel Using Orthogonal Frequency Division Multiplexing. IEEE Transactions on Communications, 33 (7), 665–675. doi: 10.1109/tcom.1985.1096357
2. Lee, J., Han, J.-K., Zhang, J. (2009). MIMO Technologies in 3GPP LTE and LTE-Advanced. EURASIP Journal on Wireless Communication and Networking.
3. Bondarev, V. N., Tröster, G., Chernega, V. S. (1999). Digital Signal Processing: Methods and tools. Sevastopol: SevGTU, 398.
4. Marchuk, L. A. (1991). Spatio-temporal signal processing for radio communication lines. Lviv: YOU, 136.
5. Popovski, A. P. (1984). Statistical theory of polarization-time signal processing in communication lines. Moscow: Radio and Communications, 272.
6. Kharlanov, A. V. (2010). Building adaptive spatial-polarization radar system to protect against active noise interference with arbitrary spatial structure. System obrobki informatsii, 2 (83), 182–187.

7. Balanis, C. A., Ioannides, P. I. (2007). Introduction to Smart Antennas. Morgan & Claypool Publishers, 184.
8. Kravchenko, V. F. (Ed.) (2007). Digital signal and image processing applications in radio-physical. Moscow: FIZMATLIT, 544.
9. Popovski, V. V., Kolyadenko, U. U. (2003). Problems and methods of use of adaptive interference canceller. Problems of intellectual and military transport. - St. Petersburg: International Academy of Transport, 4, 294–302.

10. Zhuravlev, A. K., Lukoshkin, A. P., Poddubnyi, S. S. (1983). Signal processing in adaptive antenna arrays. Lviv: Publishing House of Leningrad University, 240.
11. Volosyuk, V. K., Kravchenko, V. F. (Ed.) (2008). Statistical theory of radio systems and radar remote sensing. Moscow: FIZMATLIT, 704.
12. Stefania, S., Issam, T., Matthew, B. (2011). LTE – The UMTS Long Term Evolution: From Theory to Practice. John Wiley and Sons Second Edition, 217–222.

*Рекомендовано до публікації д-р техн. наук, професор Лошаков В. А.  
Дата надходження рукопису 26.03.2015*

**Ali Abdourahamane Ahmed**, Postgraduate Student, Department of Telecommunication Systems and Networks, Kharkiv National University of Radio Electronics, ave. Lenina, 14, Kharkov, Ukraine, 61000  
E-mail : alzabirmaowy@gmail.com

УДК 658.62.018.012

DOI: 10.15587/2313-8416.2015.41589

## НАУКОВІ ПІДХОДИ ДО ОЦІНЮВАННЯ ЯКОСТІ ПРОЦЕСІВ

© О. О. Катрич

*Для оцінювання якості процесів пропонується застосовувати інформаційну модель процесу, для чого необхідно мати оцінки узагальнених показників якості різних процесів у безрозмірній величині. Проаналізовано існуючі залежності оцінювання процесів та виявлено їх недоліки. Запропоновано інші залежності, які краще підходять до оцінювання процесів*

**Ключові слова:** процес, кваліметрія, функція бажаності, процесна модель, якість процесу, інформаційний зв'язок

*To assess the quality of the processes it is proposed to apply the information model of the process, which is necessary to have estimates of the generalized indicators of the quality of various processes in non-dimensional value. The existing dependencies of assessment processes are analyzed and their disadvantages are identified. Other dependencies that are better suited to the assessment processes are proposed*

**Keywords:** process, qualimetry, desirability function, process model, process quality, information communication

### 1. Вступ

Забезпечення високого рівня якості продукції національного виробника завжди актуальна, так як це дозволяє конкурувати на вітчизняних та міжнародних ринках. Так як Україна задекларувала курс на вступ в Європейський Союз, то випуск конкурентоспроможної продукції особливо актуально сьогодні, тому промисловим підприємствам і організаціям необхідно застосовувати комплексний підхід до забезпечення якості продукції та готуватися до жорсткої конкурентної боротьби в умовах Європейської ринкової економіки.

Країни-лідери світової економіки довели свій досвід успішного розвитку підприємств, який показує, що для досягнення високого рівня якості продукції важливу роль відіграє системний підхід до виробничих процесів та впроваджують системи управління якістю (СУЯ) відповідно до вимог міжнародних стандартів ISO серії 9000.

Більшість українських підприємств, незважаючи на інтенсивну роботу з впровадження СУЯ, не змогли добитися покращення економічних показників, тому постає актуальне завдання знайти причини та дати рекомендації щодо розроблення критеріїв її

функціонування, а також створення методів їх параметричного аналізу і комплексного оцінювання, доведених до практичної; реалізації.

### 2. Постановка задачі та літературний огляд

Аналізуючи вимоги міжнародних стандартів [1, 2], можна зробити висновок, що для системного управління якістю на підприємстві необхідно всю діяльність розділити на процеси, оцінювати їх та за результатами оцінок вводити коригувальні та запобіжні дії. Отже необхідно оцінювати процеси, а щоб ними можна було управляти, оцінки повинні бути кількісними, тобто мати числове вираження. На сьогодні не існує єдиної методики оцінювання процесів, так як кожне підприємство унікальне за різними показниками і їх унікальність залежить від виду продукції, що випускається або послуги, масштабів і структури підприємства, від кваліфікації персоналу та багатьох інших факторів. Крім цього велика різноманітність кваліметричних методів оцінювання вимагає глибокого наукового дослідження в частині оптимальності та ефективності їх використання для кожного конкретного випадку. Так як СУЯ постійно удосконалюються, постійно розвиваються інструменти і